



## 广州特域机电有限公司

地址：广州市番禺区钟村镇钟创路50号

GUANGZHOU TEYU ELECTROMECHANICAL CO., LTD.

Add: No.50, Zhongchuang Road, Zhongcun town, Panyu District, Guangzhou, China.  
Post Code: 511495 Email: marketing@teyu.com.cn

Tel: +86-20-89301885 89301886 Fax: +86-20-84309967

全国服务热线：400-600-2093 www.teyu.com.cn



teyuchillers

特域冷水机微信服务平台  
TEYU CHILLER SERVICE WECHAT ID



CW-3000 Series



## 工业冷却机 使用安装说明

### CW-3000 Series

### INDUSTRIAL COOLER USER MANUAL

Thank you for using the machine from  
 GUANGZHOU TEYU ELECTROMECHANICAL CO., LTD.

Please read the installation instructions carefully before  
 installing and operating and keep it properly.

This installation instructions is not a quality assurance.  
 GUANGZHOU TEYU ELECTROMECHANICAL CO.,LTD.

Reserves the right to the interpretation of correction of  
 typographical errors, improper mentioned  
 information and product improvement.

The amended content will be reprinted in installation  
 instructions without notice in advance.



**THIS PRODUCT IS INDUSTRIAL EQUIPMENT.  
 PROFESSIONAL USE ONLY!**

## CONTENTS

CAUTIONS	8
CONTOUR AND PARTS INTRODUCTION	9
INSTALLATION	10
FLOW ALARM AND OUTPUT PORTS	11
MAINTENANCE	12
SPECIFICATIONS	12
SIMPLE TROUBLESHOOTING	13
PACKING LIST	13

## CAUTIONS

**1 Please ensure that the power supply and electrical outlet are in good contact and the earth wire must be firmly grounded!**

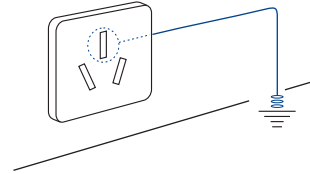

**2 Please make sure there is stable and normal voltage for the working chiller!**

As the refrigeration compressor is more sensitive to the power supply and voltage, so the operating voltage of our standard product is of 200 ~ 250V (110V model is of 100 ~ 130V). If you do need a wider operating voltage range, customization is available for us.

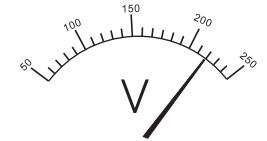

**3 Unmatched power frequency can cause the chiller damage!**

Please choose model of 50Hz or 60Hz according to actual circumstance.

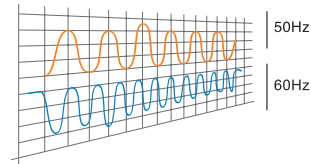

**4 To protect the pump, it's strictly forbidden to run the chiller without water in the storage water tank!**

The new machine is packed after draining whole water in the tank, so please make sure the tank has water inside before machine starting, otherwise it's easily to have the pump damaged.  
 To drain through circulating pump is strictly prohibited!



**5 Please be sure that the air inlet and air outlet are in good ventilation!**

There must be at least 50cm from obstructions to the air outlet which is in the back of the chiller, and should leave at least 30cm between obstructions and the side air inlet.

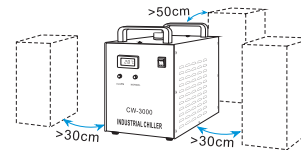

**6 The cooling water must be drained if the cooler is out of use for long time Or before being transported.**



**7 To protect laser heating devices, the radiator fan of cooler will suspend to work when water temperature is lower (about 10 °C), and it will restart to run when water temperature rises to higher (about 20 °C).**

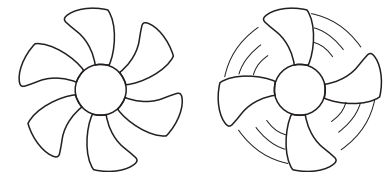

10°C

20°C

# PARTS INTRODUCTION

## FRONT

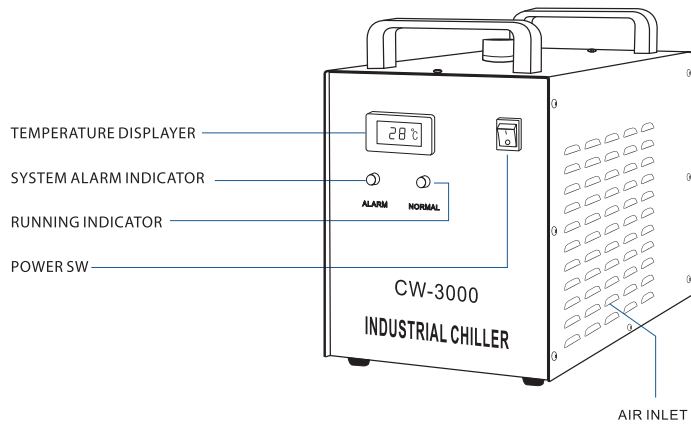

## BACK

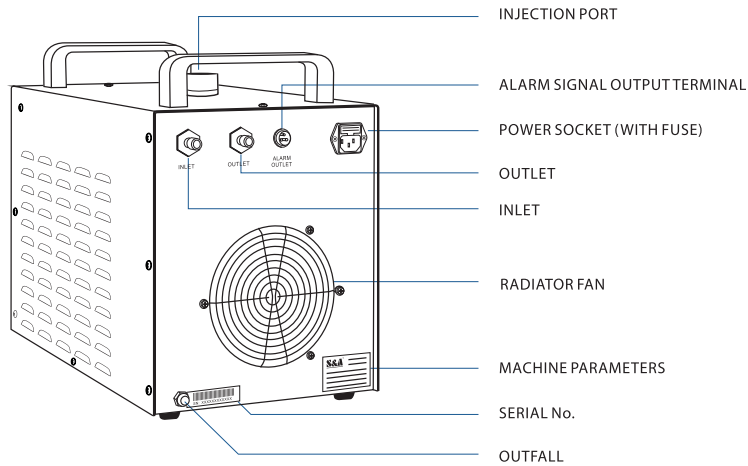

# INSTALLATION

It is very simple to install this industrial water cooler. The installation for the first time of the new machine can be carried out by following steps:

1

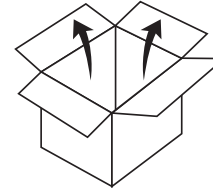

Open the package to check if the machine is intact and all the necessary accessories are completed.

2

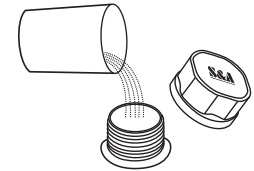

Open the injection port to feed cooling water. (Do not spill out the water!)

3

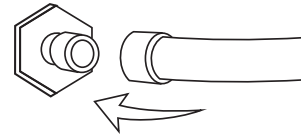

Connect the water inlet and outlet pipes well according to system conditions.

4

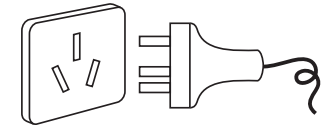

Plug in power and turn on the power switch. (Do not start up without water in the water tank!)

(1) Power switch turned on, the circulation pump of the chiller starts working. The first time of operating may cause more bubbles in the pipe leading to a flow alarming occasionally, but running for a few minutes later, it will go back to normal.  
(2) After the first boot, you must immediately check whether the water pipe leaks.

5

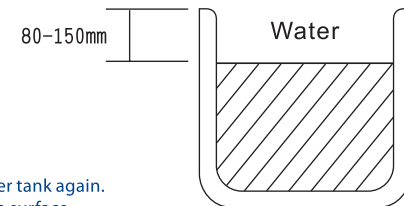

Check the water level of the water tank again. (It should be 80-150mm from the surface of water to the injection port)

# FLOW ALARM AND OUTPUT PORTS

In order to guarantee the equipment will not be damaged while cooling water circulation is out of control, CW-3000 series water cooler possess a low flow alarm protection.

## Flow alarm output ports and the wiring diagram

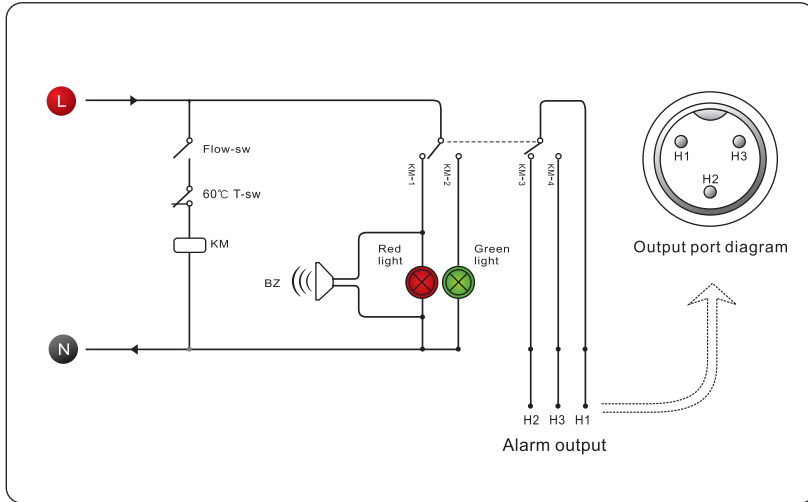

## ALARM DESCRIPTION

Causes of the cooling water circulation loop alarm and the working condition table

CONDITION \ DISPLAY	GREEN LIGHT	RED LIGHT	BUZZER	OUT H1、H2	OUT H1、H3
Normal	● On	⊗ Off	🔊 No voice	🔴 Off	🟢 On
Water stops up	⊗ Off	● On	🔊 Voice	🟢 On	🔴 Off
Surpasses 60°C	⊗ Off	● On	🔊 Voice	🟢 On	🔴 Off
Pump breakdown	⊗ Off	● On	🔊 Voice	🟢 On	🔴 Off
Alarm of water shortage	⊗ Off	● On	🔊 Voice	🟢 On	🔴 Off
Faulted circuit	⊗ Off	● On	🔊 Voice	🟢 On	🔴 Off
Power outage	⊗ Off	● On	🔊 Voice	🟢 On	🔴 Off

Note: the flow alarm port is connected to the normally open relay and normally closed relay contacts, requiring operating current to be less than 5A, working voltage less than 300V.

# MAINTENANCE

1. To ensure good heat dissipating, please open the lid to clean the dirt after the cooler used in long-term.
2. Users in cold area should use noncorrosive antifreeze fluid.





# SPECIFICATIONS

MODEL	CW-3000AG	CW-3000DG	CW-3000AF	CW-3000DF	CW-3000AK	CW-3000DK
Voltage	AC 1P 220V	AC 1P 110V	AC 1P 220V	AC 1P 110V	AC 1P 220V	AC 1P 110V
Frequency	50/60Hz					
Current	0.45A	0.9A	0.45A	0.9A	0.5A	1.0A
Cooling	50W/°C					
Capacity	9L					
Inlet and outlet hold	External Φ 10mm brass connector		Φ 8mm speedy connector			
Max. Lift	10M			70M		
Max. Flow	10 L/min			2 L/min		
Protection	Flow alarm			Flow alarm		
N.W	9.5Kg			12Kg		
G.W	12Kg			14.5Kg		
Dimensions	49 x 27 x 38cm (L*W*H)					
Packing dimensions	59 x 39 x 48cm (L*W*H)					

# SIMPIE TROUBLESHOOTING

FAILURE	FAULT CAUSE	APPROACH
Machine turned on but unelectrified	Power cord is not plugged in place	Plug the power cord in place
	Fuse burnt-out	Replace the fuse inside the power interface which is in the back of machine
Flow alarm (panel red light) with water pipe directly connect to the outlet, inlet, there is no water flow	Water level in water tank is too low	Feed water and check the pipe leakage
When used with the device, flow alarm (panel red light), but a direct connection with the pipe outlet and inlet, there is water flowing but not alarming	Water level in water tank is too low	Feed water and check the pipe leakage
Ultra-high temperature	Chiller of poor ventilation	To improve the ventilation
	Excessive heat load	Reduce the heat load or to use other models
A normal boot, but the fan does not work	The water temperature below 20°C	A normal phenomenon, no processing
Switch on with alarming after adding water or changing water	Water drop in electric circuit	Natural drying or drying off cap
	Damaged pumps dry transfer	To replace or repair water pumps, prohibited anhydrous boot
Slow outfall drainage	The injection port is not open	Open the injection port

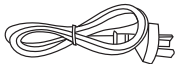
# PACKING LIST

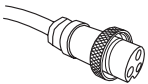
<b>1</b> 1 unit of industrial cooler 	<b>2</b> 1 copy of user manual 	<b>3</b> 1 pc of power cord 	<b>4</b> 1 pc of connection hose 
<b>5</b> 2 pcs of sealed hoop (optional) 	<b>6</b> 1 pc of alarm signal output plug 	<b>7</b> 1 pc of spare fuse (Held in the spare fuse holder of power socket) 