



RDC644XG Controller User Manual

Shenzhen RuiDa Technology CO., LTD

Tel: 86- 0755-26066687

Fax: 86-0755-26982287

Web: www.rd-ac.com

E-Mail: support@rd-ac.com

Add: 1B-1, Building 5, Tian'an Nanyou Industry Area,
Dengliang Road, Nanshan District, Shenzhen, P.R.C.

Copyright Declaration

Shenzhen Ruida Technology Co., Ltd. (hereinafter referred to as “Ruida Technology”)

All rights reserved.

1. Ruida Technology holds the patent rights, copyrights and other intellectual property rights for this product and its related software. Without authorization, none company or organization or individual is allowed to copy, manufacture, process and use this product and its relative parts directly or indirectly, otherwise shall be investigated for legal responsibility according to the law.
2. Ruida Technology is entitled to increase or reduce and modify the products and functions of this product stated herein as well as amend any documents attached to this product, without prior notification.
3. The users should peruse this manual prior to using the product stated herein, Ruida Technology shall not be responsible for the direct, indirect, special, incidental or corresponding losses or damages arising out of improper use hereof or of this product as below:
 - Users using this manual or product improperly
 - Users not follow the related safety operation rules
 - The loss caused by the forces of nature
4. The machine in operation is dangerous, so the users are obliged to design and institute the effective mechanism for error handling and safety protection. Ruida Technology shall not undertake any duties or responsibilities for the incidental or corresponding losses arising therefrom.

CONTENTS

Copyright Declaration.....	2
Chapter 1 Overview.....	6
1.1 Briefing.....	6
1.2 Description of Controller Model.....	6
1.3 Comparison of Controller Performance.....	7
Chapter 2 Installation Size.....	10
2.1 Installation Size of Controller.....	10
2.2 Size of Panel.....	11
Chapter 3 Controller Real Picture and Interface.....	12
3.1 Picture of Controller.....	12
3.2 Pictures of Panel.....	13
3.3 Electrical Connection of Control System.....	14
Chapter 4 Interface Signal of Controller.....	15
4.1 Interface of Main Power Source CN0.....	15
4.2 Controller-display panel Interface HMI.....	15
4.3 Udisk Interface.....	15
4.4 PC-USB Interface.....	15
4.5 Ethernet Interface.....	15
4.6 General /Dedicated Output Port CN1.....	16
4.7 General /Dedicated Input Port CN2.....	16
4.8 4-axis limit Input Interface CN3/CN4.....	17
4.9 X/Y/Z/U-axis Motor Driver Interface AXIS_X~AXIS_U.....	18
4.10 Laser Power Control Interface CN5/CN6.....	18
Chapter 5 Examples of Laser Power Interface.....	20
5.1 Brief Introduction.....	20
5.2 Examples of Glass tube Laser Power.....	21
5.3 Examples of RF- CO2 Laser.....	22

Chapter 6 Interface Examples of Step-servo Motor Driver	23
6.1 Brief Introduction.....	23
6.2 Examples of Motor Driver Connection.....	24
Chapter 7 Examples of IO-Port Wiring	25
7.1 Input port.....	25
7.2 Output port.....	26
Chapter 8 Human-Computer Interface Operating Instruction	27
8.1 Panel and Keys.....	27
8.1.1 The Operation Panel.....	27
8.1.2 Introduction to the Keys.....	27
8.2 Main Interface Introduction.....	29
8.2.1 The main interface.....	29
8.2.2 Speed Setting.....	30
8.2.3 Max/Min power keys.....	30
8.2.4 Layer Parameters Setting.....	31
8.3 Z/U Key Menu.....	32
8.3.1 Z-axis move.....	33
8.3.2 U-axis move.....	33
8.3.3 Axes reset+.....	33
8.3.4 Manual set+.....	34
8.3.5 Laser set+.....	34
8.3.6 Origin set+.....	35
8.3.7 Set Factory Para.....	36
8.3.8 Def Factory Para.....	37
8.3.9 Auto Focus.....	37
8.3.10 Language Setting.....	37
8.3.11 IP Setup.....	37
8.3.12 Diagnoses.....	38
8.3.13 Screen Origin.....	39
8.4 File Key.....	39
8.4.1 Memory File.....	39
8.5 Alarm Info.....	42
Chapter 9 Manufacturer/User Parameters Details	44
9.1 Manufacturer Parameters.....	44
9.2 User Parameters.....	47



Chapter 1 Overview

1.1 Briefing

RDC644XG system is a new generation system for control of laser engraving and cutting, which is developed by RD technology, Ltd. High hardware stability, high voltage or static electricity rejection, and friendly 3.5TFT man-machine display. This system is provided with stronger software function including perfect 4-axis motion control function, large-capacity file storage, two-channel adjustable digits laser power control interface, USB driver of stronger compatibility, multi-channel general/special IO control, and, this system can communicate with PC by USB2.0 or Ethernet, and the communication mode is automatically checked by the system.

1.2 Description of Controller Model

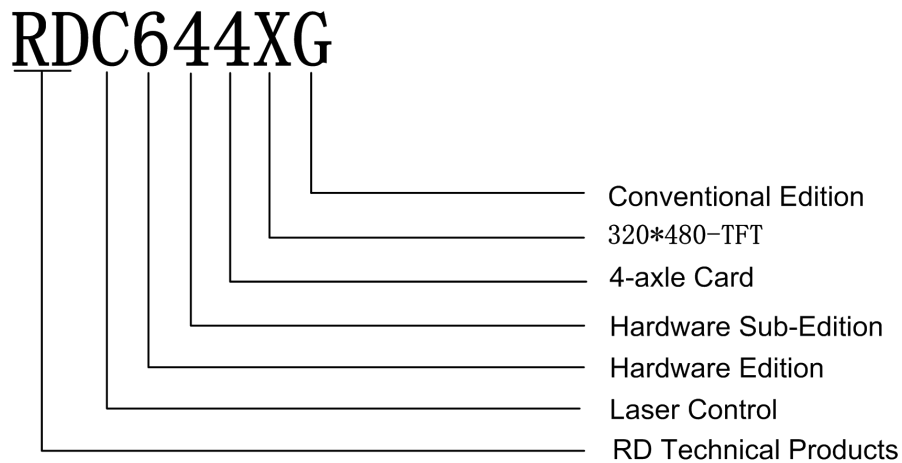

1.3 Comparison of Controller Performance

		RDLC420	RDC6332G	RDC6342G	RDC644XG
Power Feature		One-way 5V, one-way 24V, independent	Only one-way 24V (compatible with 36V for power supply, but not recommended)	Only one-way 24V (compatible with 36V for power supply, but not recommended)	Only one-way 24V (compatible with 36V for power supply, but not recommended)
Laser Port Feature		One-way digit and one-way analog	Two-way digits and two-way analog port, settable independently and non-interacted	Two-way digits and two-way analog port, settable independently and non-interacted	Two-way digits port, settable independently and non-interacted
USB Feature	Copying Speed	Common	Quick	Quick	Very Quick
	Compatibility	Support USB disks with small capacity	Support all USB disks with different capacities	Support all USB disks with different capacities	Support all USB disks with different capacities
Memory Feature	Capacity	64M	256M	256M	128M
	Fault Tolerance	Common	Capable of checking defective track and formatting and good in fault tolerance	Capable of checking defective track and formatting and good in fault tolerance	Capable of checking defective track and formatting and good in fault tolerance
General IO Feature	Input Port	Two ways	4 ways (two for general, two for specialties)	4 ways (two for general, two for specialties)	4 ways (two for general, two for specialties)
	Output Port	1-way (low current, so additional drive is needed)	4-ways (500mA high current for each, OC output, no reverse current protection)	4-ways (500mA high current for each, OC output, no reverse current protection)	4-ways (500mA high current for each, OC output, reverse current protection included)
Software Feature	Power-off restart for Engraving	YES	YES	YES	YES
	Multi-origin Logics	NO	YES	YES	YES
	Parameter	NO	YES	YES	YES

	Backup Logics				
	Work time Preview	NO	YES (the work time accurate to 1ms)	YES (the work time accurate to 1ms)	YES (the work time accurate to 1ms)
	Online Update Controller Program	NO	YES	YES	YES
Display Feature	Online Modification Laser Power/Speed	YES	YES	YES	YES
	Offline Modification Layer parameters	NO	YES	YES	YES
	Online Update Startup Display	NO	YES	YES	NO
	File dynamic/static preview	NO	YES	YES	YES
	Run progress bar display	NO	NO	NO	YES
	Modification Factory/User's para on display	NO	YES	YES	NO
	Display type	128*64, dot display	320*240 TFT display	320*240 TFT display	320*480 TFT display
Motion-axis Feature	Soft Limit	YES	YES	YES	YES
	Hard Limit	NO	YES	YES	YES
	Z-axis Linkage	NO	YES	YES	YES
	Feeding Feature	Single direction	Single/double direction for option	Single/double direction for	Single/double direction for option

				option	
	Power-on Resetting	Fixed	Configurable for each axes	Configurable for each axes	Configurable for each axes
	Key Speed	Fixed	Configurable	Configurable	Configurable
	Axis	4	3 (Z axes is configurable to flat or feedin axes)	3 (Z axes is configurable to flat or feedin axes)	4
Encryption Feature		Encryption based on the PC time	Realtime clock and battery integrated for hardware encryption	Realtime clock and battery integrated for hardware encryption	No realtime clock, but encryption included
Communication Mode		USB2.0	10/100MHZ Ethernet or USB2.0	10/100MHZ Ethernet or USB2.0	10/100MHZ Ethernet or USB2.0, communication mode is automatically checked

Chapter 2 Installation Size

2.1 Installation Size of Controller

The unit of all sizes is millimeter (mm) and the size accurate to 0.1mm (the four holes are symmetrical).



Figure 2.1-1

2.2 Size of Panel

The unit of all sizes is millimeter (mm) and the size accurate to 0.1mm.

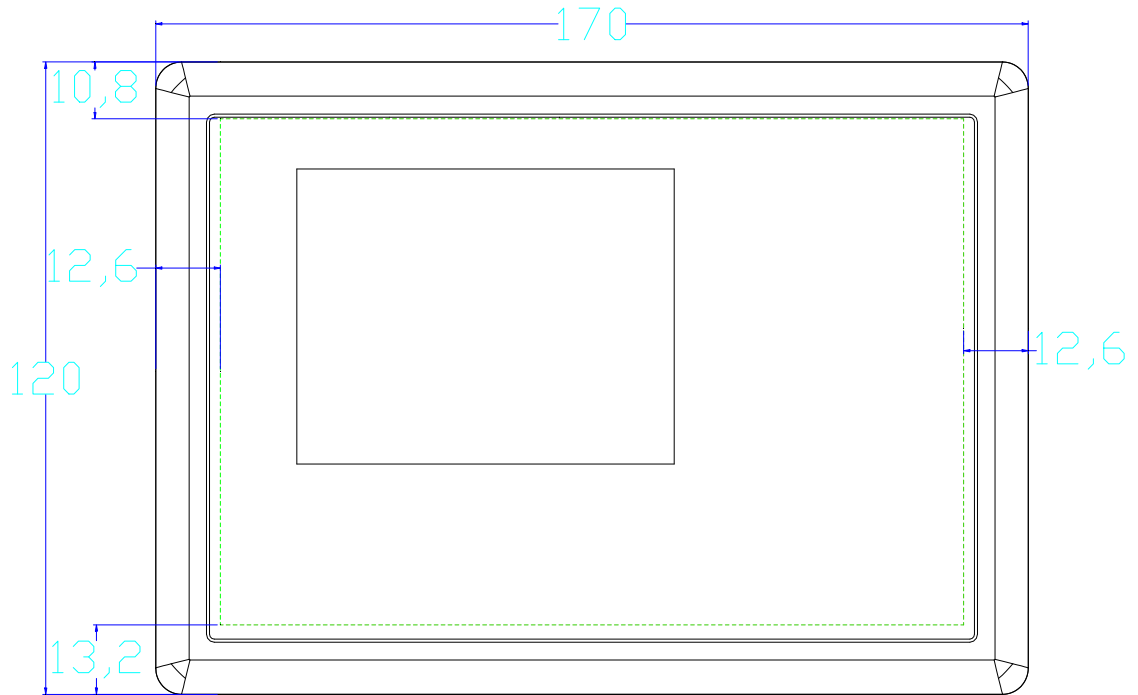

Figure 2.2-1

Chapter 3 Controller Real Picture and Interface

3.1 Picture of Controller

For more detailed pin description, see the Chapter 4: Description of Interface Signal for Controller.

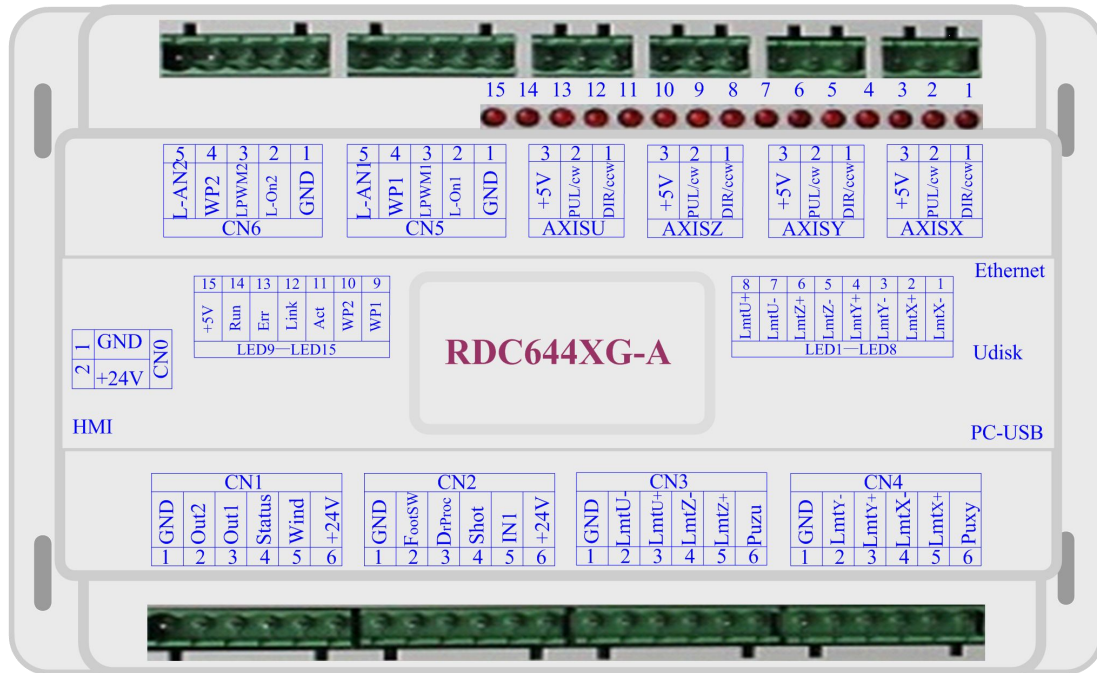

Figure: 3.1-1 Picture of Controller

3.2 Pictures of Panel

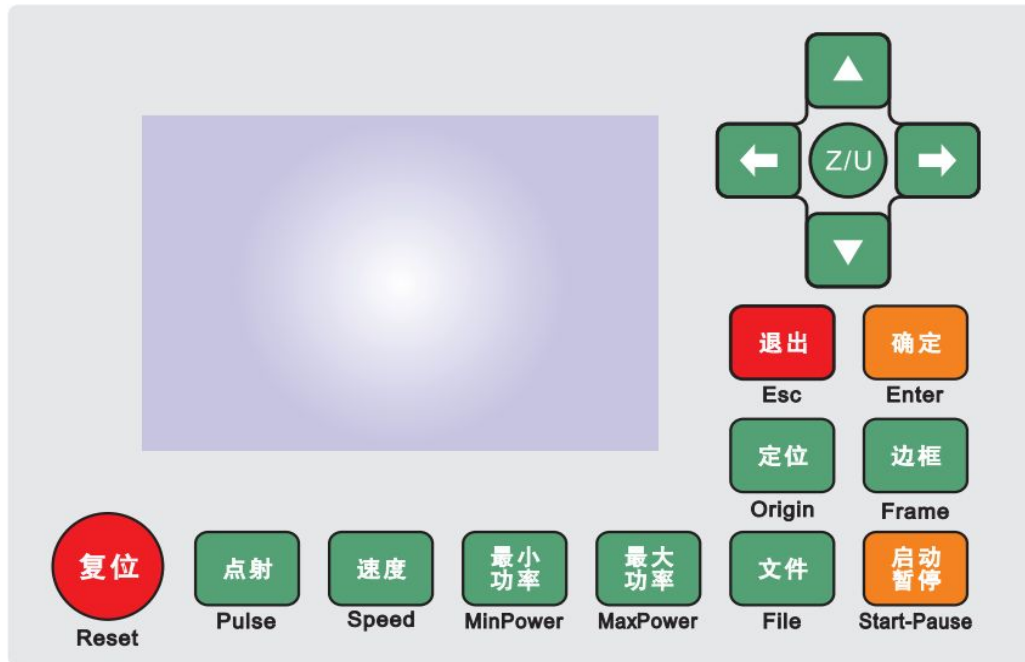

Figure: 3.2-1 Picture of Panel

3.3 Electrical Connection of Control System

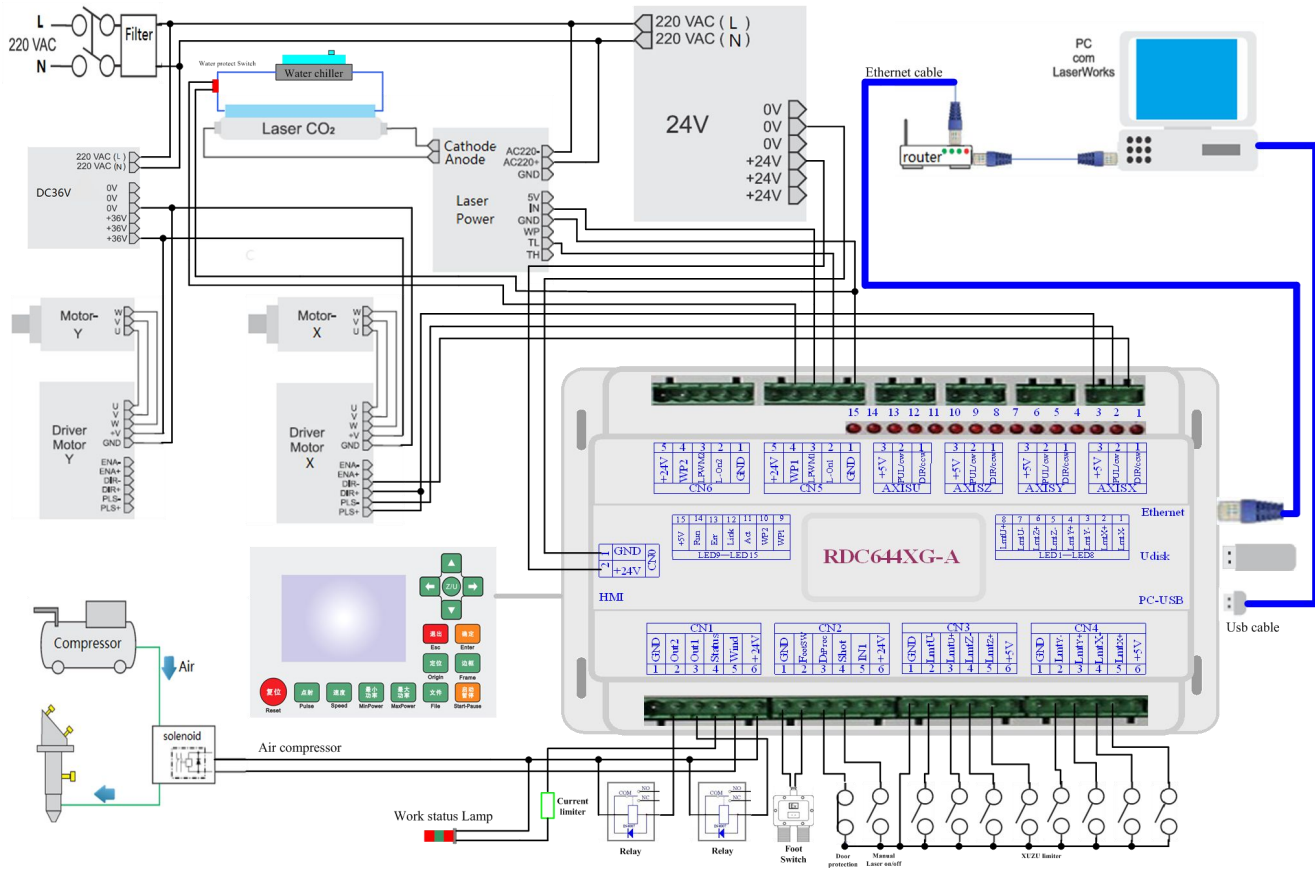



Figure 3.3-1 Electric Connection

Chapter 4 Interface Signal of Controller

4.1 Interface of Main Power Source CN0

Pin	Symbols	Definitions
1	GND	24V power ground (input)
2	+24V	24V power positive (input)

 Caution	<p>This control system employs single 24 power supply. For a certain margin, it is suggested to select 24V/2A above power. Besides, this system is compatible with 36V power, that is to say, the 36V power of Motion driver can directly be connected to this main power port of this system, but generally it is not suggested to do so.</p>
---	--

4.2 Controller-display panel Interface HMI

The connecting wire is parallel line of pin-to-pin.

4.3 Udisk Interface

Udisk is a USB-AM interface; the controller visits the u-disk by this interface.

4.4 PC-USB Interface

PC-USB is a USB-BM interface. The controller may communicate with PC by this port.

4.5 Ethernet Interface

Using this interface, the controller can communicate with PC by 10/100MHZ Ethernet.

 Caution	<p>Pin to Pin Ethernet parallel line is recommended.</p>
---	--

4.6 General /Dedicated Output Port CN1

Definition of general/dedicated output port

Pin	Symbols	Definitions
1	GND	Power ground (output)
2	Out2	General output, with the function reserved.
3	Out1	General output, with the function reserved.
4	Status	General output for the signal port of running status. If this port is externally connected with the relay, the relay coil is broken over when it works; no influence is produced when it suspends working. When its work ends or is stopped manually, the relay coil will be cut off.
5	Wind	General output for blower control. When the blower control is enabled, this port will output the control signal of the blower, otherwise it will output other special control signals. When the blower is connected and its control enabled, the blower switch can be set separately on each layer. If the relay is connected externally, the relay coil will be broken over when the blower is on; the relay coil will be cut off when the blower is off.
6	+24V	24V Power positive output (If the interface of main power source is powered with 24V power supply, this pin should be 24V; if it is powered with 36 V power supply, this pin should be 36V.)



Prompt

All outputs are isolated through the optocoupler, and 500mA current for each, OC gate output, each can directly drive the 6V/24V relay.

4.7 General /Dedicated Input Port CN2

Pin	Symbols	Definitions
1	GND	Power ground (output)
2	FootSW	Input port of foot switch. The connection method is: when the pedal is stepped down, the low-level signal will be inputted to this port; when the pedal is released, the port will be disconnected or the high-level signal can be inputted to this port; when the stepped-down pedal is held for not less than 100 ms, if the machine lies idle, it can be started for work; if the machine is in the working state, the work will be suspended; of the machine is in the suspension, the work will

		be restarted, that is to say, the function of the pedal switch is the same as that of the “Start/Pause” key. If the interval time to the first stepping-down of the pedal should be less than 100ms when the pedal is stepped down once again, the second stepping-down of the pedal will be considered invalid by the controller.
3	DrProc	Input from protective port. If the machine needs to be protected in the special state (such as door open protection), the protective signal can be inputted from this pin. This pin can be enabled and prohibited. This signal is not inquired by the controller if this pin is prohibited; if this pin is enabled, when the input is high-leveled or this input port is suspended, the machine will be protected, the work suspended and the laser closed.
4	Shot	Input for manual laser on/off. Low level is to open laser and high level or no-connection is to close laser.
5	IN1	General Input, with the function reserved.
6	+24V	24V Power positive output (If the interface of main power source is powered with 24V power supply, this pin should be 24V; if it is powered with 36 V power supply, this pin should be 36V.)

4.8 4-axis limit Input Interface CN3/CN4

X/Y axis limit input CN4.

Pin	Symbols	Definitions
1	GND	Power ground (output)
2	LmtY-	The limit from axis Y- and Y to 0 coordinate
3	LmtY+	The limit from axis Y+ and Y to max. coordinate
4	LmtX-	The limit from axis X- and X to 0 coordinate
5	LmtX+	The limit from axis X+ and X to max. coordinate
6	Puxy	5V Power positive (output)

The limit polarity is optional, that is to say, when the motion axis reaches the limit position, it will trigger a low-level signal so as to make the corresponding LED (under the cover) light; when the motion axis leaves the limit position, it will trigger a high-level signal or disconnect the limit signal so as to make the limit indicator go out, but when it leaves the limit, the corresponding indicator will light and the limit polarity become positive. The mistaken setting of limit polarity will result that the limit can't be detected when the system is reset so as to lead to the collision of axis.

The pin definitions of Z/U axis limit input CN3 are the same as CN4.

X/Y/Z/U-axis limit inputs are compatible to 5V/12V/24V logic level inputs.

4.9 X/Y/Z/U-axis Motor Driver Interface AXIS_X~AXIS_U

The interfaces of the four motion axis are the same. The AXIS-X interface is exemplified.

Pin	Symbols	Definitions
1	DIR	Directional signal (OC output)
2	PUL	Pulse signal (OC output)
3	+5V	5V Power positive (output)

The polarity of directional signal for driver pulse signal can be set. Where a certain axis is reset, it will move to the opposite direction of machine origin, which means the polarity of directional signal for this axis is not correct. In such a case, the connection between this axis and the motor driver can be broken first (otherwise the controller cannot be detected to the limit so as to lead to the collision of this axis), and then such a polarity can be corrected after this axis is reset completely. Upon the correction, the reset key can be pressed against to reset the controller.

And, the pulse signal can be falling edge valid or rising edge valid. The default setting is falling edge valid.

 Prompt	The Pulse signal and the directional signal are all OC outputs. The Controller must be common anode with the motor driver
--	---

4.10 Laser Power Control Interface CN5/CN6

This control system has two independent and adjustable digital laser power control interfaces. Signals of the two interfaces are similar and the first digital interface (CN5) is hereby example:

Pin	Symbols	Definitions
1	GND	Power ground (output)
2	L-ON1	Laser-enabled control interface 1. When the laser is the RF laser, this pin will not be used; 2. When the laser is a glass tube, if the used laser is outputted in the low-level form, this pin will be connected with the laser power enable end and used to control the ON/Off of laser.
3	LPWM1	Power control interface of laser/laser tube

4	WP1	<p>1. When the laser is the RF laser, this pin will be connected with the laser RF-PWM end;</p> <p>2. When the laser is a glass tube, this pin will be connected with the laser power PWM end and used to control the power of the laser.</p> <p>The input port of water protector for the first laser power source. When the water protector 1 is enabled, the controller will detect the input port of water protector 1. If this port is of low level, it will be deemed normal; if this port is of high level, the controller will forcibly close the laser to suspend the work in progress and the system will warn. If the water protector 1 is not enabled, the controller will not detect the input port of water protector 1 and so the water protector 1 can be unconnected.</p> <p>Water protection input must be 24V logic level.</p>
5	L-AN1	<p>The analog signals for Laser Power. If Glass Tube is used, this pin is recommended to control the power of the Laser.</p>

 Prompt	<p>Please correctly select the laser type in the factory parameters.</p>
--	--

Chapter 5 Examples of Laser Power Interface

5.1 Brief Introduction

This control system has two independent and adjustable digital laser power control interfaces, which can be used to control glass tube laser power and RF-laser.

Please correctly select the laser type in the factory parameters when connecting to different laser types, otherwise, the laser switching is incorrect.

5.2 Examples of Glass tube Laser Power

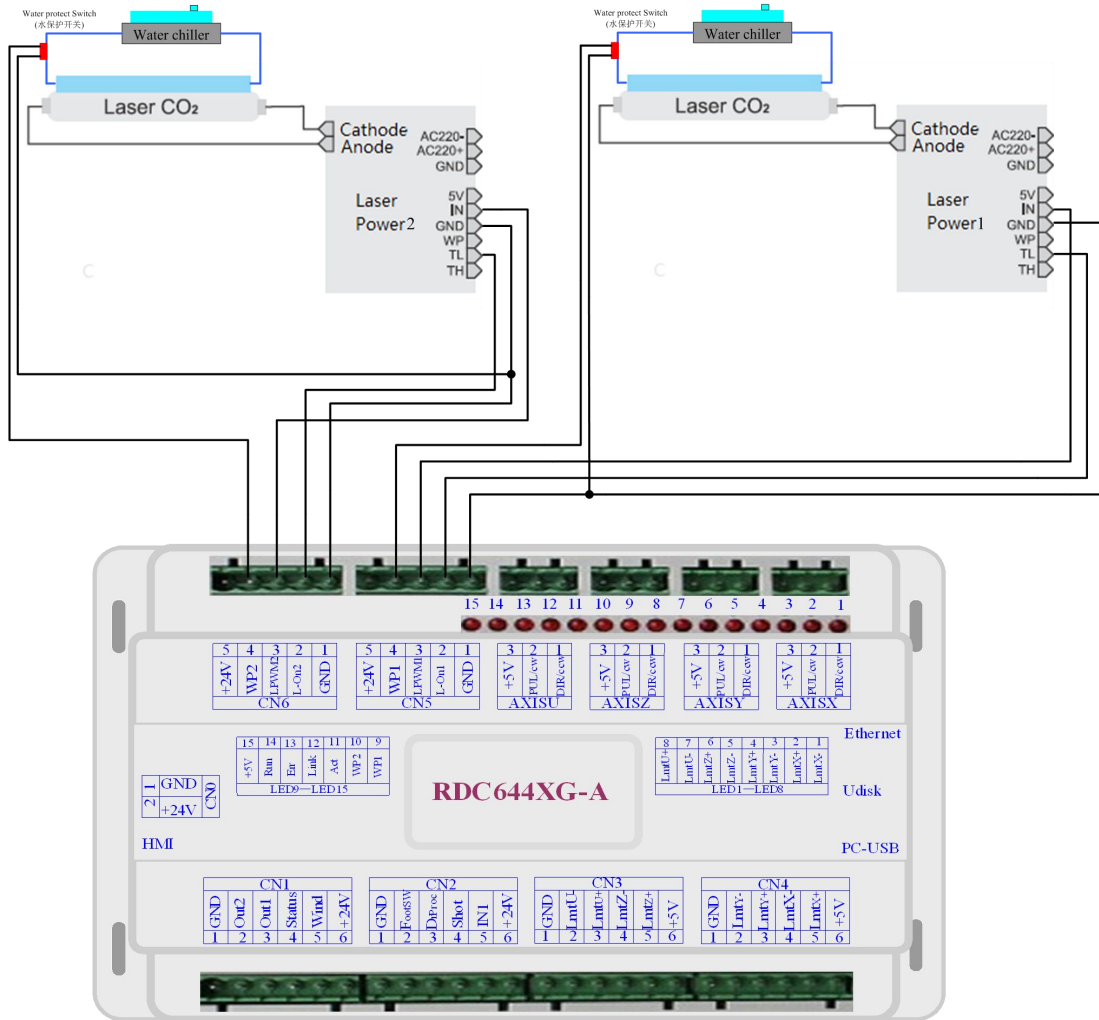

5.3 Examples of RF- CO2 Laser

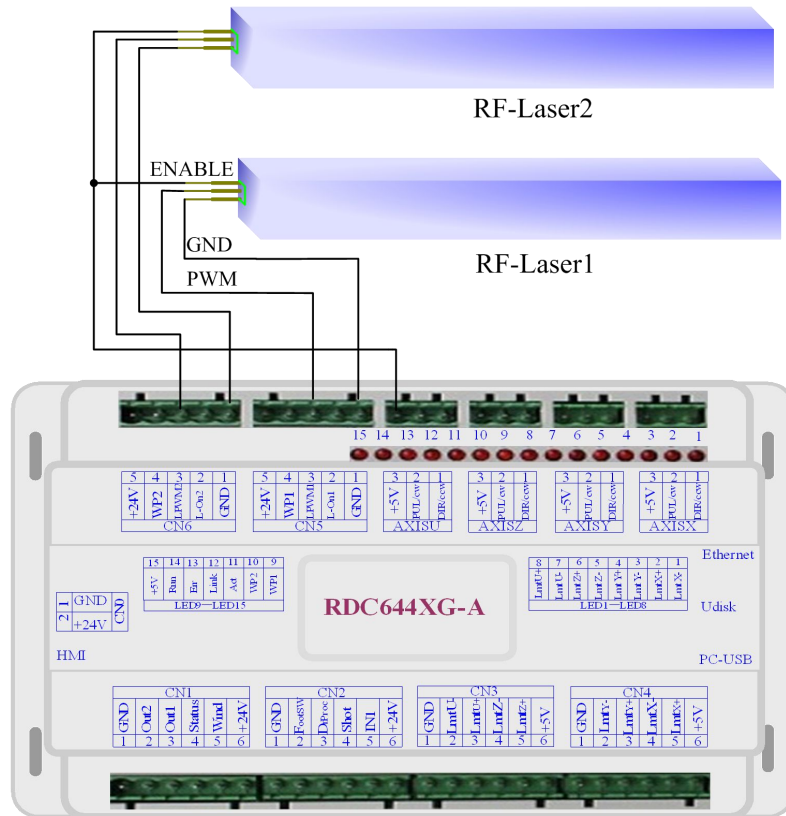

Chapter 6 Interface Examples of Step-servo Motor Driver

6.1 Brief Introduction

The input signal end of step-servo motor driver employs the opto-isolator technology. For the step pulse signal, some isolate the side OC diode from cutoff to conduction (e.g. the valid falling edge of pulse signal inputted from the diode minus end) and some do so from conduction to cutoff (e.g. the valid rising edge of pulse signal inputted from the diode minus end).

When it is indicated whether the pulse signal of motor driver is the valid rising edge or the valid falling edge, it will be subject to the pulse signal inputted from the minus end of side OC diode.

Some input signals of motor driver are independent and some are internally of common anode, so some have 4 external leading-out wires and some 3 wires (only the pulse and directional signals are counted) as shown in Figure 6.1-1 and 6.1-2.

RDC644XG Controller has four groups of 3-wires motion driver interface, each interface has one direction signal, one pulse signal, and one 5V positive output, the direction signal and the pulse signal are all OC output.

RDC644XG controller must be common anode with the motor driver. The polarity of the direction signal can be changed in the factory parameters, and the valid edge of the pulse signal can also be changed.

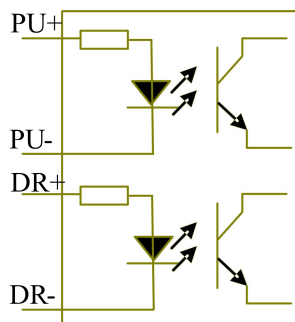

Figure: 6.1-1 Four Inputs, Independent Input Signal of Driver

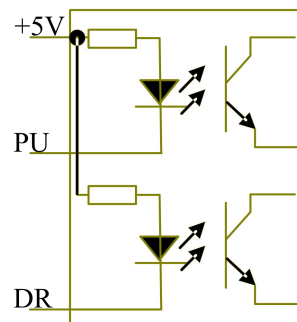
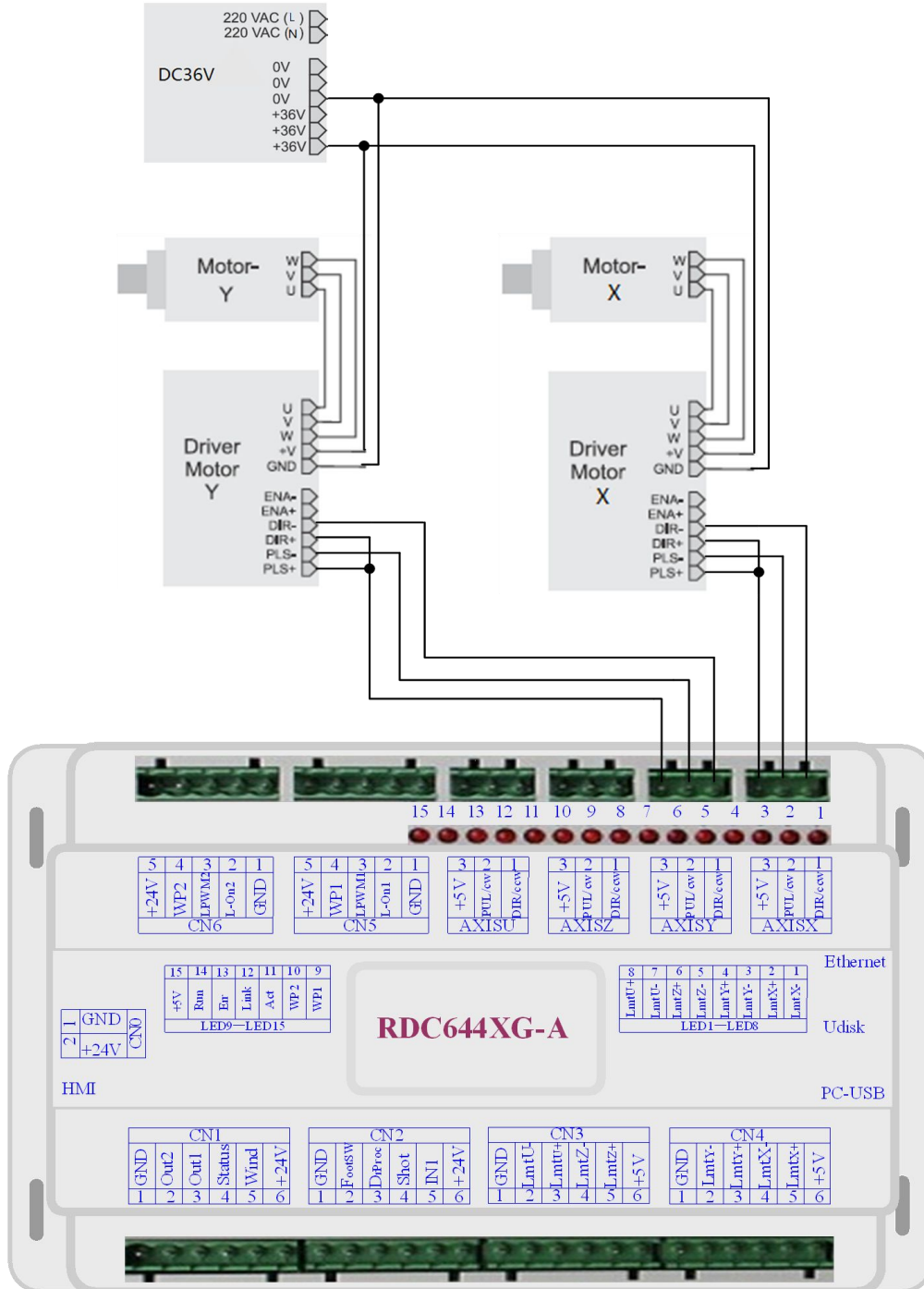

Figure: 6.1-2 Three Inputs, Common-anode Input Signal of Driver

6.2 Examples of Motor Driver Connection



Chapter 7 Examples of IO-Port Wiring

7.1 Input port

The two water protection inputs are WP1 and WP2 with 24V logic level; all other inputs are compatible with 5V/12V/24V logic level.

Input connection is shown as below:

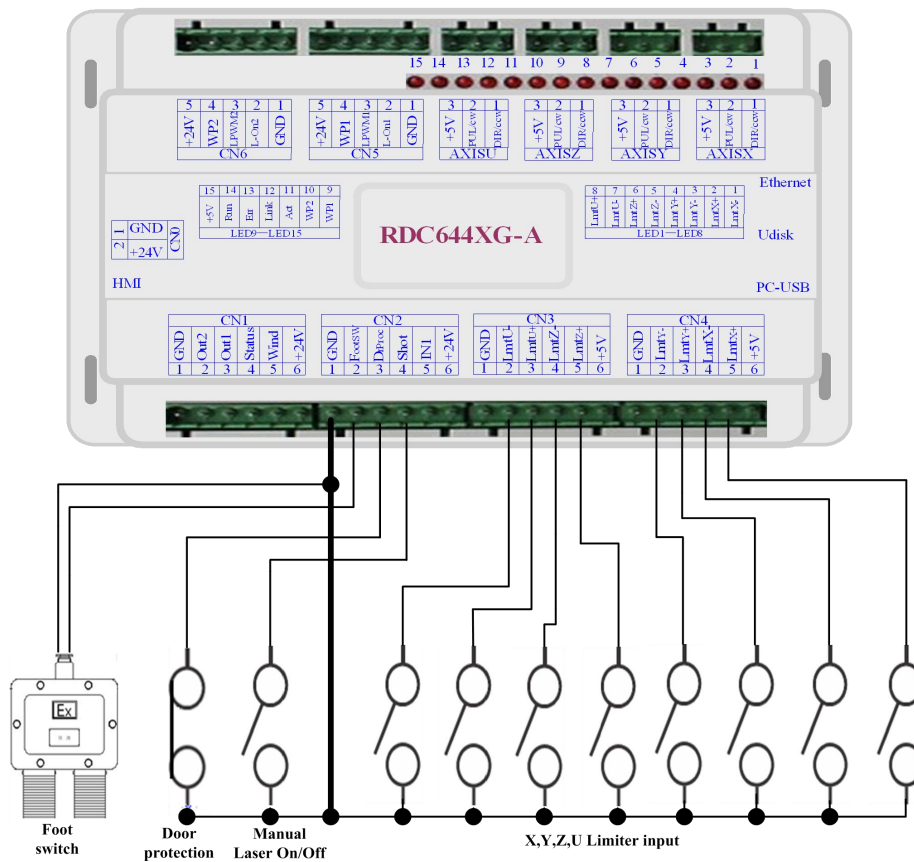

Figure 7.1-1 Input Example

7.2 Output port

All outputs are isolated through the optocoupler, and 500mA current for each, OC gate output, each can directly drive the 6V/24V relay, led lamp, buzzer etc.

Output connection shown as below

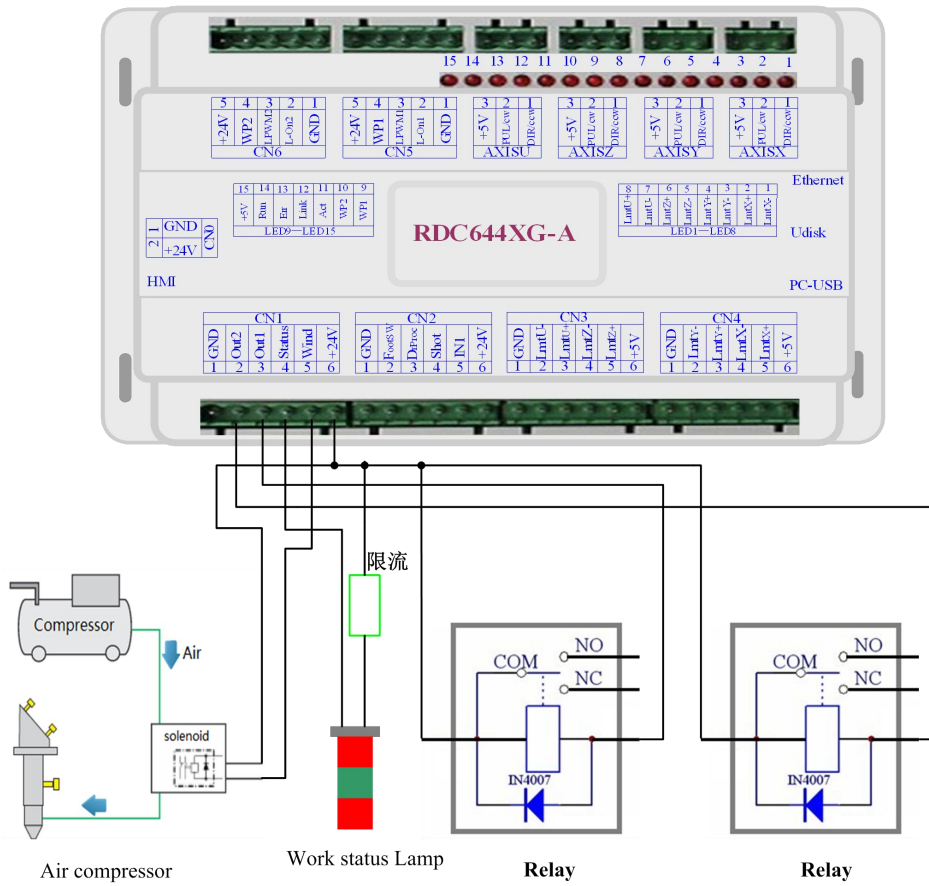
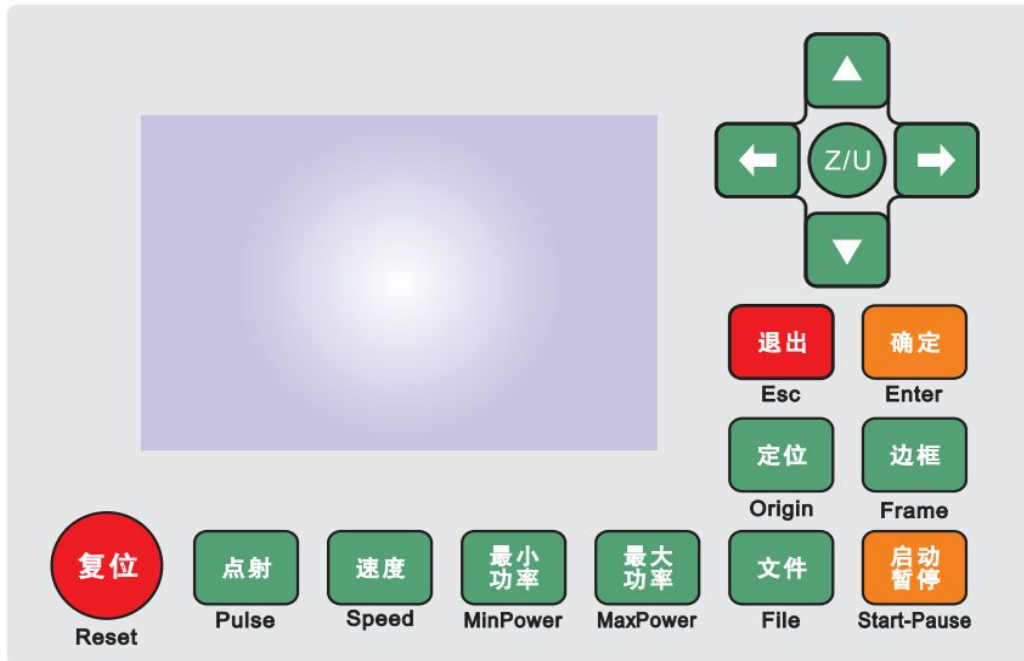

Figure 7.2-1 Output Example





Chapter8 Human-Computer Interface Operating Instruction





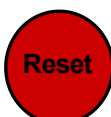



8.1 Panel and Keys

8.1.1 The Operation Panel

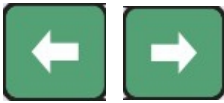

8.1.2 Introduction to the Keys

-  **Reset** : Reset the controller;
-  **Origin** : Set the relative origin;
-  **Pulse** : The laser tube emits laser;
-  **Frame** : Frame of the current file;
-  **File** : The management of the memory and U disc files;

-  : Speed of the current running layer, or set the direction keys move speed;
-  :Set the max laser power of the current running layer, or set the power of “Laser” key;
-  :Set the min laser power of the current running layer,
-  :To start or pause the work;
-  :To move the X axes or the left/right cursor;
-  :To move the Y axes or the up/down cursor;
-  : The Z/U key can be pressed when the system is idle or the work is finished. On pressing this key, it will show some entries in the interface, each entry includes some functions, Z axes move, U axes move, each axes to go home etc.;
-  :To stop work, or to exit to some menu;
-  : Validate the change;

8.2 Main Interface Introduction

8.2.1 The main interface

When the system is powered on, the screen will show as below:

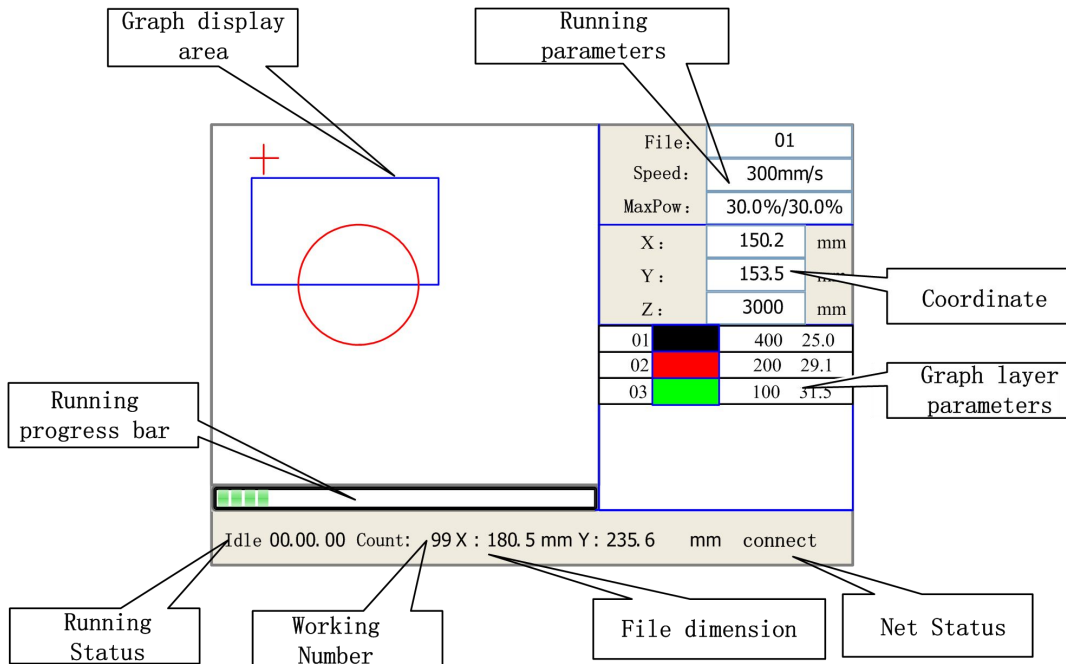

Figure 8.2-1

- Graph Display Area: To display the whole file's track, and display the running track.
- Running parameters display area: To display the running file's file number, speed, max power etc.;
- Coordinate display area: To display the current coordinate of X,Y and Z axes
- Layer parameters display area: To display the layers' information of the current file, such as max or min power, speed etc. When system is idle, double click the layer, then users can change the layer's parameters and the changing would be saved.
- Running Status: To display the current status of the machine, such as Idle, Run, Pause, Finish, etc.;
- Running Progress Bar: To display the progress bar of the current running file;
- Working Number: To accumulate the work number of the current file.
- File Dimension: To display the dimension of the current file;
- Net status: To display the connecting status of the Ethernet.

When work is idle or finished, all keys can be pushed, users can select a file to run, set some parameters, preview to a select file etc. But, when work is running or paused, some keys will not respond when they are pushed.

8.2.2 Speed Setting

Push the “Speed” key when the screen is on the main interface, it will show as below:

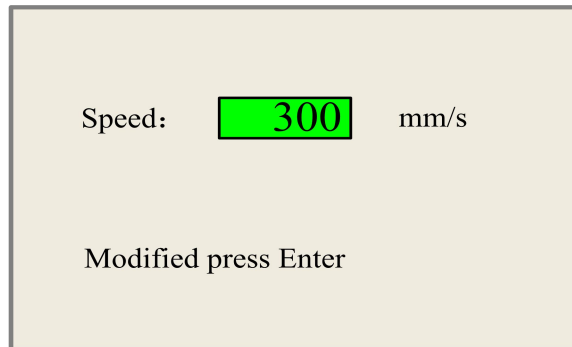

Figure 8.2-2

Push the “X+/-“ Keys to move the cursor in the numeral area, and push the “Y+/-” keys to change the value, then push the “Enter” key to save the change, push the “Esc” key to invalidate the change.

8.2.3 Max/Min power keys

Push the “Max Power” or the “Min Power” keys when the screen is on the main interface, it will show as below:

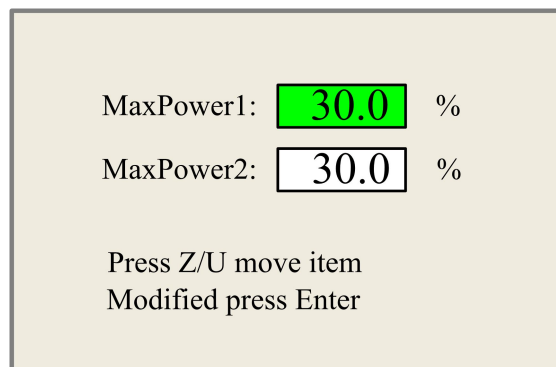

Figure 8.2-3

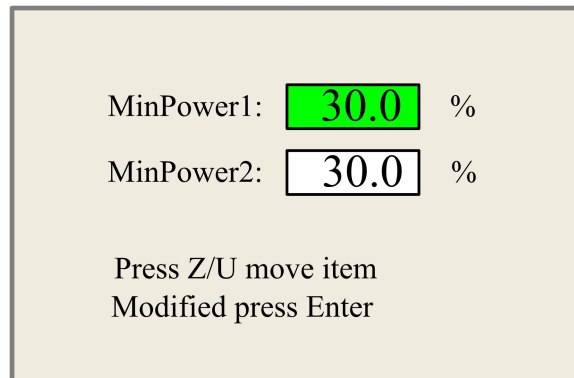

Figure 8.2-4

When “Z/U” key is pushed, the green block can move up and down to denote the changing item, then “Y+/-” keys and “X+/-” keys can be used to change the value.

8.2.4 Layer Parameters Setting

After selecting a file to preview on the main interface, user can push “Enter” key to let the cursor move to the first layer, then “Y+/-” Keys can be pushed to select the intent layer, on that time, user can push “Enter” key to check the selected layer’s parameters, show as below:

01		400	25.1
02		200	29.1
03		100	31.5

Figure 8.2-5

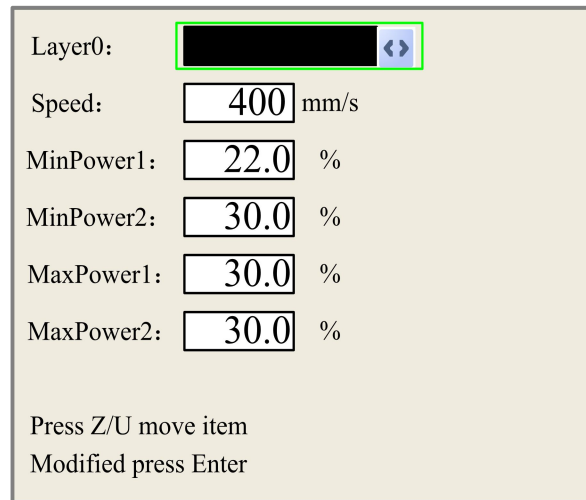

Figure 8.2-6

User can push “Z/U” Keys to move the green block on the intent parameter, then to change the parameter if needed. “OK” to validate the change, and “Esc” to invalidate the change.

8.3 Z/U Key Menu

The Z/U key can be pressed when the system is idle or the work is finished. On pressing this key, it will show some entries in the following interface:

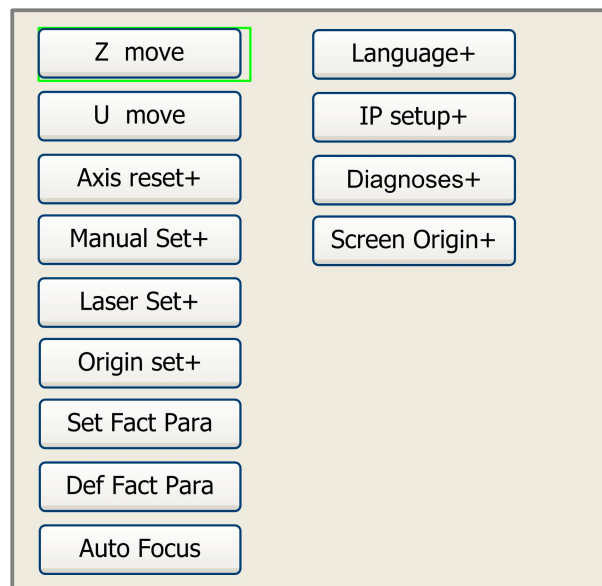

Figure 8.3-1

Push “Y+/-” keys to move the green block to the anticipant item, and then push the “Enter” key to display the sub menu.

8.3.1 Z-axis move

When the green block is on “Z Move” item, “X+/-” keys can be used to move the z axes.

8.3.2 U-axis move

When the green block is on “U Move” item, “X+/-” keys can be used to move the u axes.

8.3.3 Axes reset+

When the green block is on this item, push the “Enter” key to show as below:

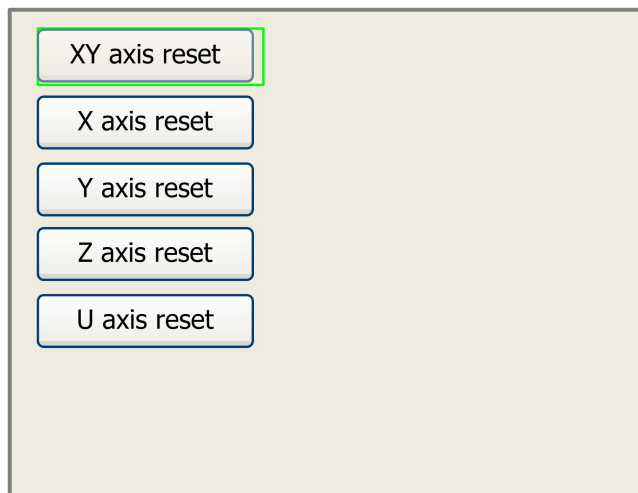

Figure 8.3-2

Push the “Y+/-“ Keys to move the cursor to one of the entry, then push “Enter” key to restart the selected axis, the screen will show some information when resetting.

8.3.4 Manual set+

When the green block is on this item, push the “Enter” key to show as below:

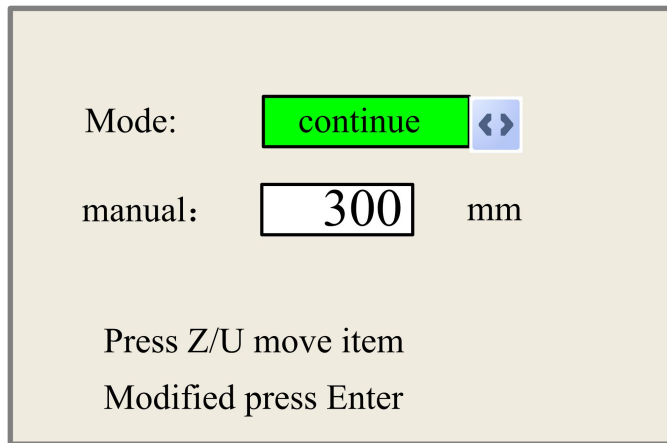

Figure 8.3-3

Push “Z/U” key to move the green block, and when the green block is on the “Mode” item, push “X+” keys to select the anticipant value, “Continue” or “Manual”. When “Continue” item is selected, then the “Manual” item is not valid, on that time, push the direction keys to move the corresponding axes, and when the pushed key is loosed, then the corresponding axes will finish moving. When the Mode item is “manual”, then pushing the direction key one time, the corresponding axes will move a fixed length, unless the scope is overstepped.

8.3.5 Laser set+

When the green block is on this item, push the “Enter” key to show as below:

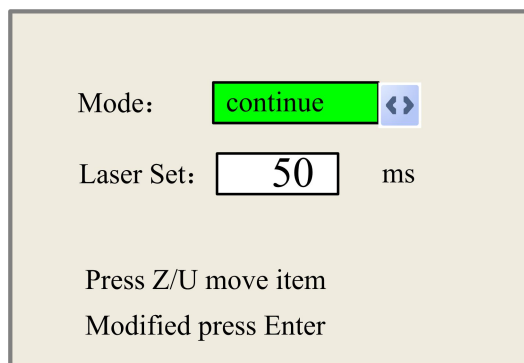
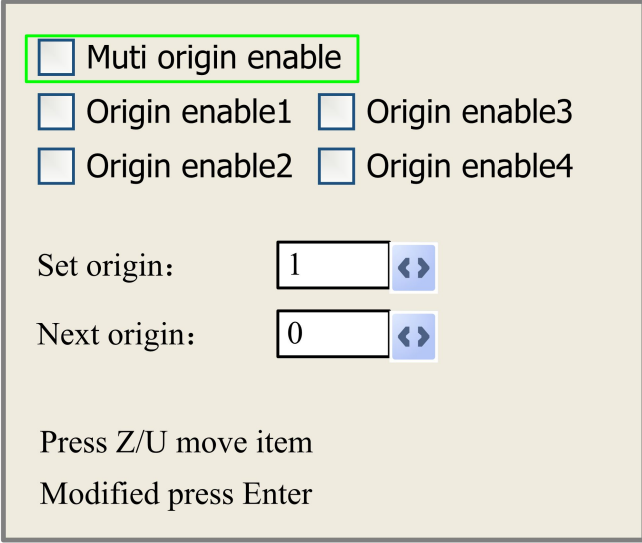

Figure 8.3-4

Push “Z/U” key to move the green block, and when the green block is on the “Mode” item, push “X+/-” keys to select the anticipant value, “Continue” or “Manual”. When “Continue” item is selected, then the “Laser Set” item is not valid, on that time, push the Laser key to splash the enabled lasers, and when Laser key is loosed, then the lasers will finish splashing. When the Mode item is “manual”, then pushing the Laser key one time, the enabled lasers will splash a fixed time.

8.3.6 Origin set+

When the green block is on this item, push the “Enter” key to show as below:



Muti origin enable
 Origin enable1 Origin enable3
 Origin enable2 Origin enable4

Set origin:
Next origin:

Press Z/U move item
Modified press Enter

Figure 8.3-5

Push “Z/U” key to move the green block to the anticipant item, and when the green block is on “enable” items, push “Enter” key to enable or disable the item, when enabled, the small diamonds is green, and when disabled, the small diamonds is grey. When the green block is on the “Set origin” item or the “Next origin” item, push the “X+/-” keys to select the value.

Pay attention to if when the green block is on the “Set origin” item, push the “X+/-” keys to select a value, then, “Enter” key must be pushed to valid the change, or, the change is invalid.

Each item introduced as below:

- **Multiple Origins Enable:** “Yes” or “No” can be selected. If you select “No”, the system will use the single-origin logic. You can press the “Origin” key and set the origin, and only this origin can become valid. If you select “Yes”, the system will use the multiple- origin logic and the “Origin” key on the keyboard become invalid. In such a case, the parameter of each origin must be set in the menu as follows.
- **Origin Enable1/2/3/4:** after the multiple-origin logic is enabled, the four origins can

independently be prohibited and enabled.

- **Set Origin 1/2/3/4:** after the multiple- origin logic is enabled, you can stop the cursor at “Set as Origin 1/2/3/4”. Press the “Enter” key on the keyboard and the system will take the coordinate figures of current X/Y axis as the corresponding ones to the origin 1/2/3/4.
- **Next Origin:** there are such five digits as 0~4 for option, which are the origins to be used for the next figure. Origin 0 means the origin set by the “Origin” key on the panel in the single-origin logic. 1~4 means the serial number of the origins in the multiple- origin logic. Next origin can be modified to any one of origin 1~4, so as to control the start location of next work (the premise is that the origin is enabled), but it can’t be modified to origin 0.

 Prompt	Once the multiple- origin logic is selected and if the serial number of the next origin is 1 and four origins are enabled, when the memory file function is started or the processing file is uploaded into the PC and this file selects “Take the Original Origin as current Origin”, the work started for each time will use different origins. The rotation order of origin is 1->2->3->4->1->2.....
--	---

8.3.7 Set Factory Para

After the “Set Fact Para” is selected and the Enter key pressed, the interface will show the specific password to be entered when set as default parameter.



Figure 8.3-6

Push “X+/-” keys and “Y+/-” keys to select the characters, and push the “Enter” key to valid the characters, when finishing enter the password ,that is to say, the six characters, if the password is error, it prompts there is some error, or, all parameters are stored.

 <p>Prompt</p>	<p>After the manufacturer regulates all parameters of the machine well (including all manufacturer parameters and user parameters), this function can be used to store the well-regulated parameters to help users to recover the original parameters (including all manufacturer parameters and user parameters) through selecting “Recover Para” when they regulate parameters improperly.</p>
--	--

8.3.8 Def Factory Para

After the “Def Fact Para” is selected and the Enter key pressed, the “Successful Recovery” dialog box will pop up to prompt that all manufacturer parameters and user parameters are recovered successfully. You can return to the previous menu by press the Enter key.

8.3.9 Auto Focus

When the cursor stops at “Auto Focus”, press the Enter key to search for the focus automatically.

8.3.10 Language Setting

The item “Language” helps you to select an appropriate language which is displayed on the panel:



Figure 8.3-7

8.3.11 IP Setup

When the green block is on this item, push the “Enter” key to show as below:

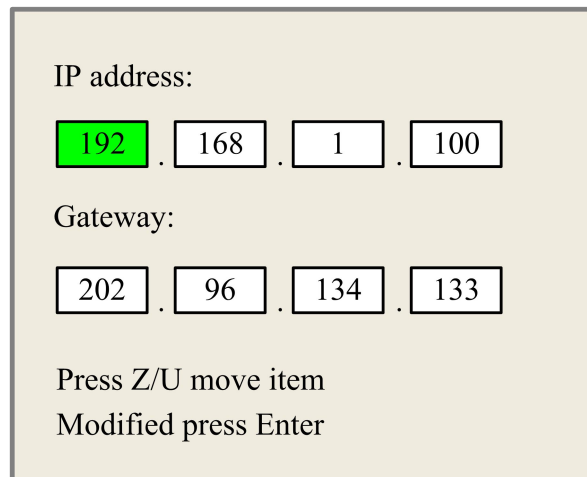

Figure 8.3-8

Push “Z/U” key to move the changing item, then push “X+/-” keys and “Y+/-” keys to change the value, when all the IP value and the Gateway value are changed, push “Enter” key to validate the change, or “Esc” key to invalidate the change.

8.3.12 Diagnoses

If the “Diagnoses” item is pressed, the system will show as below:

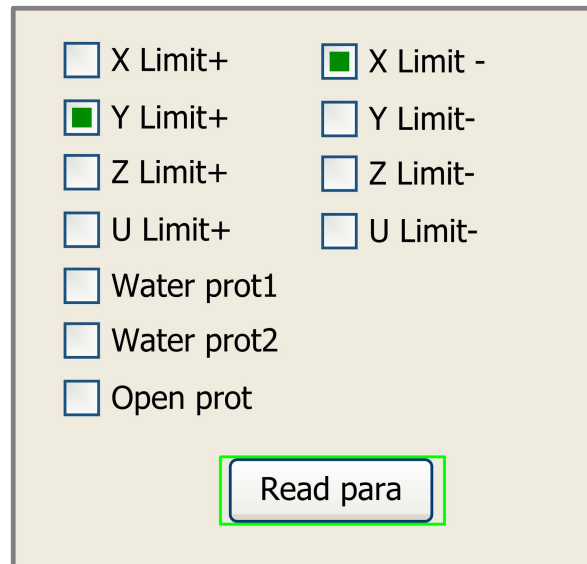

Figure 8.3-9

This interface shows some system input information, such as limiter status, the status of the water protecting, and the status of the foot switch etc.. When the input is validated, the color frame will be green, otherwise it's gray.

8.3.13 Screen Origin

If the “Screen Origin” item is pressed, the system will be showed as below:

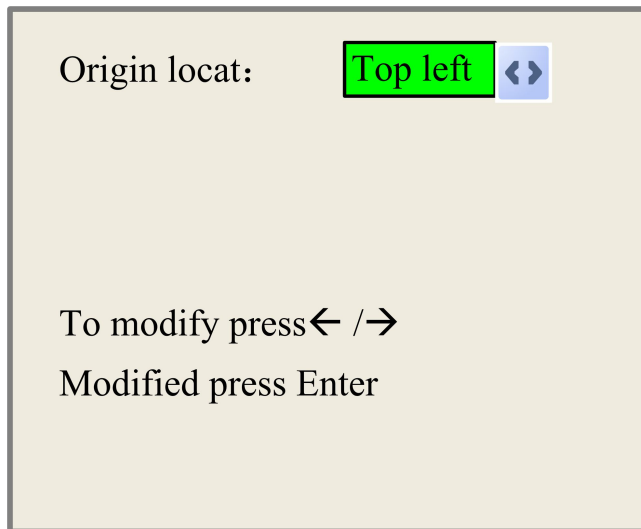

Figure 8.3-10

This function is to set the screen origin position, to choose different origin position, which can mirror the graphics on X/Y direction. The operation way as above mentioned.

8.4 File Key

8.4.1 Memory File

On the main interface, if “File” key is pressed, it will be showed as below:

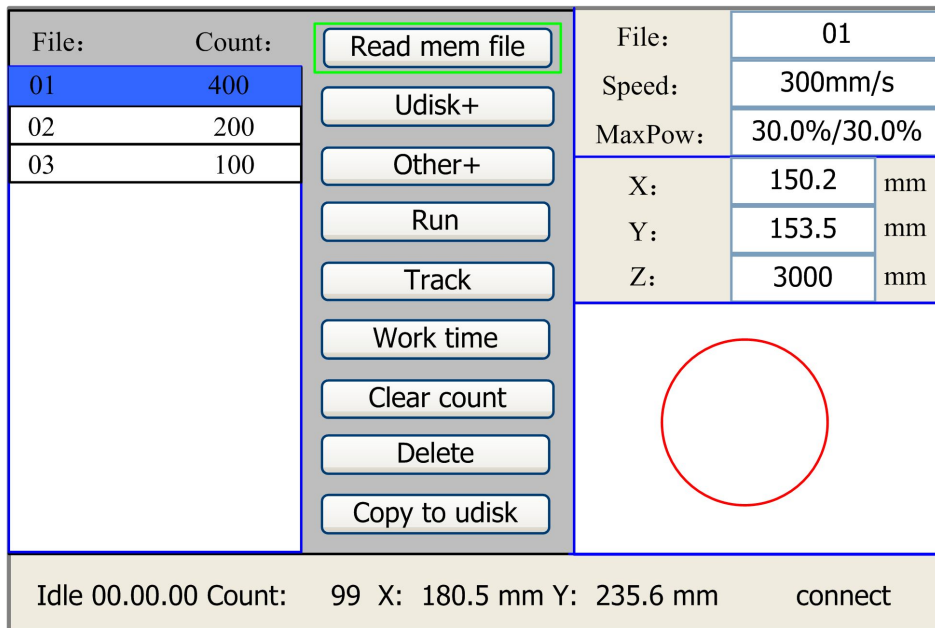

Figure 8.4-1

When showing this menu, the system would read the memory file firstly, the file name and the work times would be listed in the area, and the selected file is previewed in the bottom right area. “Y+/-” keys could be used to move the cursor on the file name list. When the cursor is on a target file name, presses the “Enter” key, the selected file will be previewed on the main interface, and then if “Esc” key is pushed, the preview will disappear.

“X+/-” keys could be used to move the cursor left and right. All the item show as below:

- **Read mem file:** read the memory file list;
- **Udisk:** read the U disk file list;
- **Other:** the other operation of the memory files;
- **Run:** To run the selected file;
- **Track:** To track the selected file, and the track mode is optional;
- **Work time preview:** To forecast the running time of the selected file, and the time is accurate to 1ms;
- **Clear count:** To clear the running times of the selected file;
- **Delete:** To delete the selected file in the memory;
- **Copy to Udisk:** To copy the selected file to Udisk;

If the “Other” entry is pressed, the system will be showed as below:

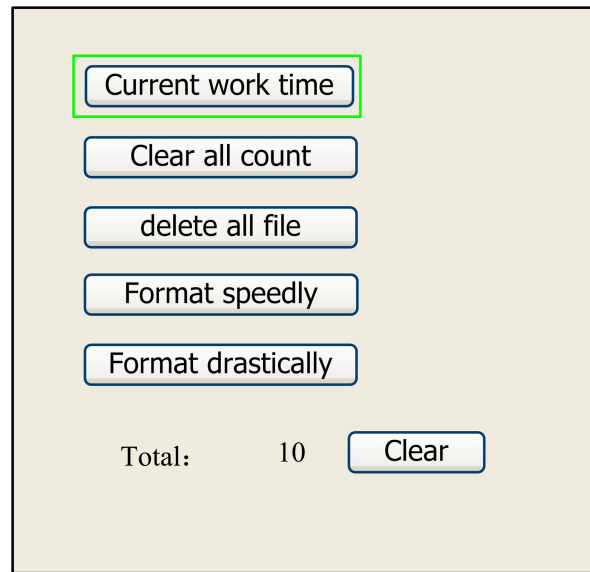

Figure 8.4-2

- **Current work time:** To forecast the running time of the current file (the current file No. is showed on the main interface), and the time is accurate to 1ms.
- **Clear all count:** To clear the running times of every file in the memory
- **Delete all file:** To delete all memory files
- **Format speedily:** To format memory speedily, and then all the files in memory will be deleted.
- **Format drastically:** To format memory drastically, and then all the files in memory will be deleted.
- **Total:** the total running times of all the files.

8.4.2 U Disk File

If press “Udisk” entry in Figure 8.4-1, the system will show as Figure 8.4-3, and the operation method is the same as Figure 8.4-1.

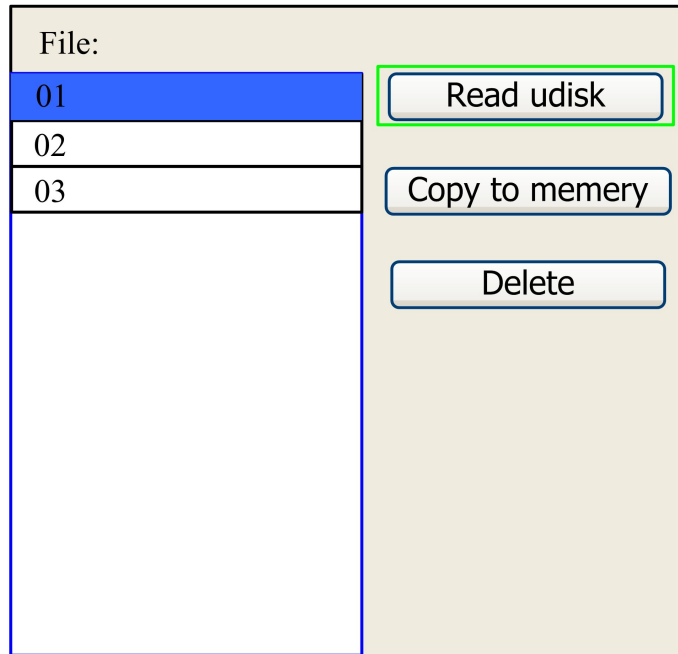



Figure 8.4-3

- **Read Udisk:** read the file list in the Udisk;
- **Copy to memory:** copy the target Udisk file to the memory;
- **Delete:** delete the selected Udisk file;

 Prompt	<p>This system supports such file formats of Udisk as FAT32 and FAT16, but it can identify them when the files are put under the root directory of Udisk. The file name of more than 8 characters will automatically be cut out by the system. The file name that has only English letters and digits will not show when they are copied to the controller. The files copied from the controller to Udisk will be placed under the root directory of Udisk.</p>
--	---

8.5 Alarm Info.

When users are operating the system, or when the machine is running, some alarm information such as water protecting error maybe popped-up as below:

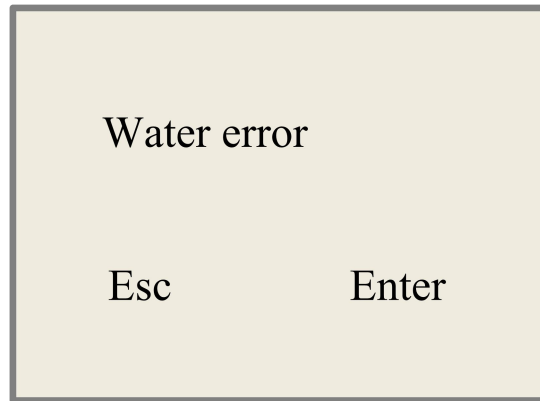

Figure 8.5-1

Push “Enter” key or “Esc” key, the system will execute.

Chapter 9 Manufacturer/User Parameters Details

9.1 Manufacturer Parameters

(1) Motor parameters

X/Y/Z/U-axis parameters

Direction Polarity: Modification of direction polarity can move the motor to the opposite direction. The modification purpose can move this axle to the origin on resetting. If this axle moves far from the origin on resetting, it means the direction polarity of this axle is wrong in setting and should be modified.

Spacing/limit Polarity: it is used to set the high and low level mode of spacing signal. When the motion axle arrives at the spacing position and input a low-level signal to the controller, the spacing polarity at this time should be set to be minus.

Key Polarity: it is used to control the movement direction of the axle that is moved through manual operation of the keys. After the direction polarity is correctly set, if you press the directional keys on the operating panel, this axle will move to the opposite direction. In such a case the polarity of keys should be modified.

Control Mode: Double-pulse or direction + single pulse are optional; in general, direction + single pulse is selected.

Hard-spacing Protection: it is used for whether the hard-spacing protection of this axle is enabled.

Reset Enable: if the machine is provided with this axle, its “Reset Enable” should be opened; if no, its “Reset Enable” should be prohibited.

Motor Stepping: it means the impulse equivalent, the absolute distance by the corresponding motion axle when a pulse is delivered to the motor. Prior to the correct setting of this value, a larger rectangle can be cut with the machine (the larger the figure is, the smaller the difference is). The motor stepping can automatically be calculated according to the figure length and measuring length.

Takeoff Speed: it means the speed of the motion axle in direct start from the idle condition. If this value is excessively large, it will make the motor lose steps, jar and even squeak; if small, it will reduce the running speed of the whole figure. If the inertia of the motion axle is larger (the axle is heavier), you can set a smaller takeoff speed; if smaller (the axle is lighter), and you can increase the takeoff speed. For

example, the typical value is 5~30mm/s.

Maximum Speed: it means the maximum limit of motion speed that this axis can bear. This parameter has something to do with the driving force of motor, the inertia of motion axle and its drive ratio. For example, the typical value is 200~500mm/s.

Maximum Acceleration: it means the maximum acceleration of the motion axis in accelerated or decelerated motion. If the acceleration is set too large, it will make the motor lose steps, jar and even squeak; if too small, it will cause the reduction of acceleration so as to reduce the running speed of the whole figure. For the axis with larger inertia, such as Y axis corresponding to the beam, its typical setting range is 800~3000mm/s²; for the axis with smaller inertia, such as X axis corresponding to the car, its typical setting range is 8000~20000mm/s².

Scope: it means the farthest distance that the motion axle can move, which is determined in accordance with the actual condition of the machine.

Key Takeoff Speed: it means the starting speed to move the axis by way of the keys on the keyboard, which can't be higher than the takeoff speed.

Key Acceleration: it means the acceleration to move this axis by way of the keys on the keyboard, which can't be higher than the maximum acceleration of this axis.

Key Reverse: to control the motion direction when move the axis by pressing key manually. When set the direction polarity parameters correctly, if press the direction key on the panel, the axis will move to the reverse direction, so enable this item.

(2) Laser parameters

Laser Tube Configuration: single laser and double lasers are available for option and set in accordance with the laser-tube quantity provided by the manufacturer.

Laser Type: glass tube, RF laser (not need pre-ignition pulse) and RF laser (need pre-ignition pulse) are available for option.

Laser Attenuation Quotiety

Laser Tube Enable: when there are double laser tubes, user can enable laser 1 and laser 2 respectively.

Maximum Power**Minimum Power****Laser PWM Frequency****Pre-burning Frequency**

Pre-burning Pulse width: when the laser is RF laser and need pre-burning pulse, you can configure the features of pre-burning pulse by pre-burning frequency and pre-burning pulse width.

Water protection enables: When the water protection enabled, the controller must connect the wiring, otherwise the machine will not emit laser. If disable, no need to connect the water protect wiring, controller will not test.

Laser PWM Frequency is used to set the pulse frequency of control signal used by the laser, in general, glass tube is about 20KHZ, RF laser is about 5KHZ; the maximum/minimum power (%) is used to set the limit power of the laser, that is to say, during the operation, the maximum power set by the user which can't be higher than the maximum power and the minimum power set by the user which no less than the minimum power. When the laser power is attenuated after using for a time, then can set the laser power by the attenuation quotiety.

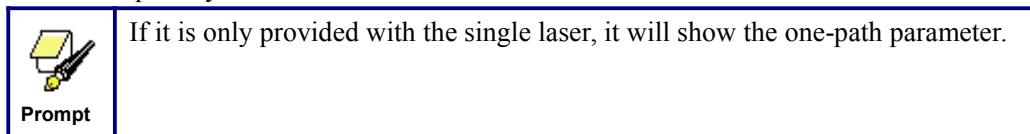
**(3) Other Manufacturer Parameters****Machine Configuration**

Machine Type: In most cases, the general engraving machine should be selected and other types used for specific purposes.

Feeding Mode: single-way mode and two-way mode for optional. If it is single-way feeding, it is unnecessary to check the coordinates, feeding can be conducted in the single-way mode; if it is two-way feeding, the system will check the maximum and minimum coordinates. The odd sequence means feeding should be done to one direction and the even sequence means feeding done to the other direction. The initial direction for the first time can be changed through setting the directional polarity or modifying the plus and minus values of the feeding length. This parameter is valid only when the “Z axes function” is configured to “Drive for Feeding axes”.

Power-Off-Restart Delay: it can be set to be 0~3000ms. After the electricity grid power-off, the power supply of the system will be not dropped to 0V at once. There is a delay during the time. The delay value set here should basically consistent with the actual off-delay value. If the deviation of set value is larger, on the de-energizing for continuous engraving, either the figure processed for the second time is not closed with that before the cutoff, or it is coincided with that too much.

Transmission Mode: generally choose “Belt Stepping Type”, the control algorithm will be changed a little when other types are selected.

 Prompt	<p>After modified the configuration parameters in the manufacturer parameters, such as directional polarity, control mode, laser type and laser PWM frequency, the system should be reset. Such a modification can function upon the resetting of the system.</p>
---	---

(4) Enable Parameters

Cover Opening Protection: If enabled this item, the controller must connect the protection wiring, otherwise, the machine will not work.

Enable the blower: if use Wind signal of output port to control the blower switch as layers, you must enable this item, otherwise, the Wind signal outputs other signal.

 Prompt	<p>The Enable Parameters are to enable or disable the above functions. If the machine is provided with the parameters for the single-laser in the manufacturer parameters, the display entry of enabling parameters will be changed accordingly.</p>
---	--

9.2 User Parameters

(1) Cutting Parameters (Only affect cutting methods)

Idle Move Speed: this parameter decides the highest speed of all non-lighting lines for the machine in the movement process.

Idle Move Acceleration: it means the highest acceleration of all non-lighting lines. Idle stroke speed and idle stroke acceleration can be set higher to reduce the working time of the whole figure, but if they are

set too high, it may cause the jarring of track, so comprehensive consideration should be given to the setting.

Turning Speed: the turning speed at closed-angle corner, the lowest speed in the whole cutting process.

Turning Acceleration: the acceleration speed at the closed-angle corner when cutting. If the two speeds are set too large, vibration will be happened when turning; if set too low, it will influence the cutting speed.

Cutting Acceleration: it means the highest acceleration value in the whole cutting process.

Acceleration Mode: it is divided into T acceleration and S acceleration. T accelerate will quicken the whole cutting process, but it will result in that its cutting effect is inferior to that of S acceleration.

One Key Setting: This is one recommended cutting parameters settings button; it is not a parameter, there are several groups of parameters under this button, which is convenient for selection.

(2) Scanning Parameters (Only affect scanning mode)

X- axis Starting Speed

Y- axis Starting Speed

X- axis Acceleration

Y- axis Acceleration

The above four parameters are used to set the starting speed and acceleration of two axles when scanning. The higher the two speeds are, the quicker the scanning is.

Scanning Line-feed Speed: this parameter is specially used to control the highest speed at which that the previous line vertically moves to the next line in the scanning mode. If the space between lines is larger during the scanning or if the distance of each block is larger during the scanning and deblocking of figure, it is necessary to position each line or block accurately. In such a case the speed of scanning line-feed can be set as a lower value.

Scanning Mode: it is divided into general mode and special mode for option. If special mode is used, the laser power should be increased. The smaller the speckle percentage is, the more the laser power reduces. The laser power to set should be larger in order to reach the same scanning depth. The purpose to select the special mode is to make the laser light at high power and short time. On the depth scanning the effect that the bottom is flatter is obtained, but it should be noticeable that if the speckle adjustment is not appropriate, it can achieve this goal. If the high power remains short, the lighting mode will influence the life of the laser. The system will default the selection of general mode.

Spot Size: When the general mode is selected as the scanning mode, this parameter will become

ineffective; when the special mode is selected, this parameter will become effective. The controller will control this parameter among 50%~99%.

	<p>The cutting and scanning parameters can't exceed the limited ones in the axle parameters. If so, the setting will become ineffective and the system will automatically cover the parameters with the axis parameters.</p>
---	--

(3) Feeding parameters

Before-feeding delay: can be set 0~300s, the upper axis will be moved after the last processing finished and delay this item. It is convenient for the user feeding and select during the delay.

After-feeding delay: settable at 0~9.9s. It can facilitate the feeding device's delaying vibrated after moving to the correct position and waiting for the 2nd work after the feeding axle stands still completely.

If feeding line-by-line: if enabled feeding line-by-line function, the virtual array graphics on Y direction will be processed in the same position.

Line-by-line feeding backlash: You can compensate the feeding length due to the inaccuracy for feeding axis moving.

(4) Reset Parameters

Reset Speed: it means the speed of X/Y-axle linkage reset to the origin.

X- axis Startup Reset

Y- axis Startup Reset

Z- axis Startup Reset

U- axis Startup Reset

You can select "Yes" or "No" in the field of the above four parameters, which is used to confirm whether each axis can be reset on the startup.

(5) Frame Setting

Frame Mode: "Blanked Bordering" means idling to start border preview; "Outputted Border Cutting" can manually cut off the well-processed figure; "4-corner Dotting" means to emit the light at four corner points of the frame to make a point and turn off light. The size and position of this figure can be checked intuitively through the four points. The bordering speed is the speed value set on the keyboard when the system is idle. For light output, its minimum/maximum power is the corresponding value set on the keyboard when the system is idle (The laser power on the 4-corner dotting means the well-set maximum

power).

Margin Distance: It means whether to extend a certain length outside the actual frame of the figure on the preview/cutting of frame.

 Prompt	If the frame crosses the border, the interface will prompt it. If the Enter key is pressed at this time, the system will cut the border at the maximum/minimum coordinates first, and then border the figure. This bordering can be given up.
---	---

(6) Other User Parameters

Array Mode: Two-way array or one-way array can be selected. Two-way array means the to-and-fro cutting of array in sequence; one-way array means the cutting of array from one direction to another. On selecting one-way array, the elements of each array are the same in action mode and completely uniform in action fluency, which takes a little more time than two-way array. Two-way array is the default option.

Back Position: The origin (the relative origin) and the machine's absolute origin can be selected. This parameter decides the parking position of laser head after each work.

Focus Setting: it means the distance from the focal point of laser head lens to Z-axle origin. When there is no automatic focusing function, this parameter becomes invalid.

Backlash X: The X axes' backlash, accurate to 1um.

Backlash Y: The Y axes' backlash, accurate to 1um.



Thank you very much for using the product from Shenzhen RuiDa Technology!

All parts of this manual description, all rights reserved by Shenzhen RuiDa Technology Co., Ltd. Without our permission, any company or individual shall not reprint, copy or distribute the content related to this product manual. We keep the rights to revise or update the contents without notice.

If any comments and suggestions please feel free to contact us.

Phone: 0755-26066687 Fax: 0755-26982287

Website: www.rd-ac.com

Address: 1B-1, Building 5, Tian'an Nanyou Industry Area,
Dengliang Road, Nanshan District, Shenzhen, P.R.C.