



A Donaldson Company

A WORLD LEADER IN FUME  
EXTRACTION TECHNOLOGY

# PrintPRO 1200 DS

PRINTING

Last Updated on 12.04.2021



Fume extraction system for dye sublimation printers.

The PrintPRO 1200 DS is an extraction and filtration unit purposely designed for dye sublimation printers. A series of coalescing filters trap glycol mist and combine it into larger droplets. These droplets then drip away from the filter when the extractor is stopped due to its reverse flow design. An automatic drain located in the base of the unit will open as soon as the extractor stops. This allows the glycol to exit the machine and be collected in the provided collection tray.

A hydrophobic HEPA filter is fitted as standard and an optional gas filter can also be fitted when the application requires it.

BOFA's automatic flow control feature is also included to ensure both optimum filter efficiency and long life.

## Technology



HEPA filter



Automatic flow control (AFC) technology



Reverse flow air (RFA) technology



Advanced carbon filter (ACF) technology



ProTECT service plan



SureCHECK quality standard

## Key features of the PrintPRO 1200 DS

**Hydrophobic HEPA filters**  
Standard

**Filters with long life and low replacement cost**  
Standard

**Automatic fluid drain**  
Standard

**VOC gas sensor (Volatile Organic Compound)**  
Optional

**Filter change / system fail signal**  
Optional

**Turbines with high airflow and pressure**  
Standard

**Automatic flow control system**  
Standard

**Fluid collection tray**  
Standard

**Remote stop / start interface**  
Optional

Contact BOFA at <https://bofainternational.com/en/contact/>

<https://bofainternational.com/en/portal/datasheets/printpro-1200-ds/>







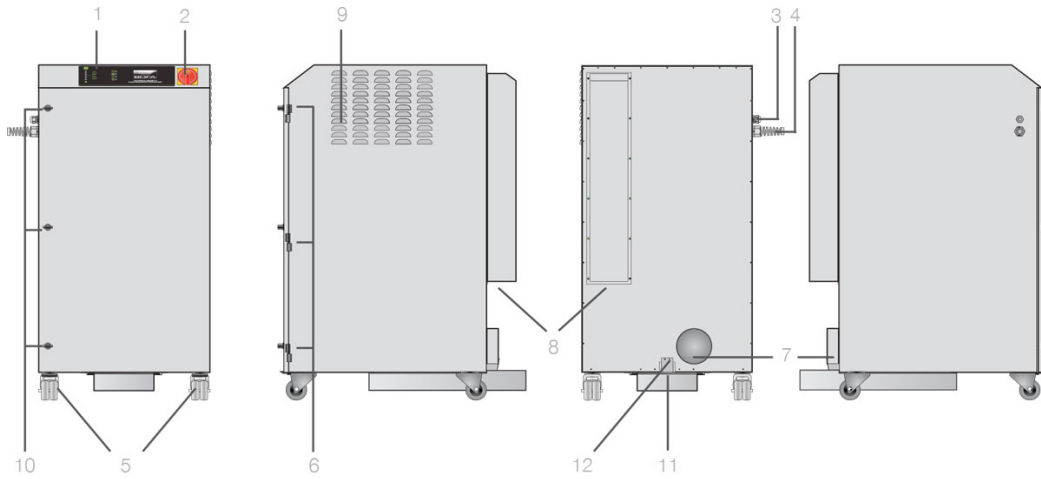

## Technical specification

- |   |                             |                                     |                          |
|---|-----------------------------|-------------------------------------|--------------------------|
| 1. Unit / filter condition display - automatic flow control | 2. On / off isolator switch | 3. Signal / interface cable         | 4. Power cable           |
| 5. Castors  | 6. Door hinge               | 7. Hose inlet connections - 125mm   | 8. Exhaust outlet        |
| 9. Motor cooling inlet                                      | 10. Door latch              | 11. Removable fluid collection tray | 12. Automatic drain tray |



## Airflow through filters

-  Chemical filter
-  HEPA filter
-  Sponge filter
-  Clean air
-  Contaminated air
-  Particulate

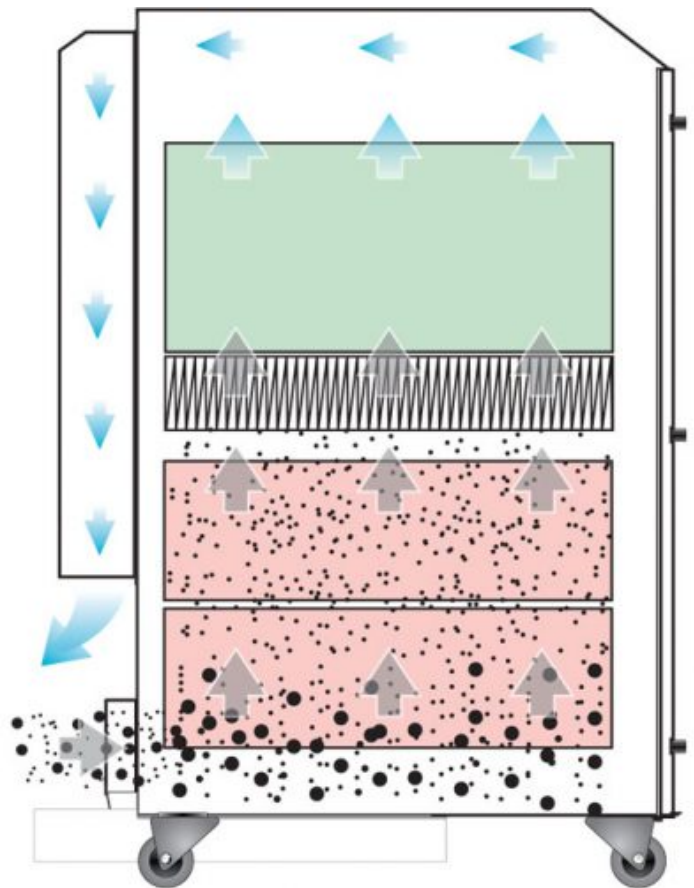

## Technical data

	230V	115V
Dimensions (HxWxD)	1170 x 600 x 713mm	46.07 x 23.63 x 28.07"

## Technical data

Cabinet construction	Stainless steel	Stainless steel
Airflow / pressure	1140m <sup>3</sup> /hr / 96mbar	670cfm / 96mbar
Electrical data	90-257v Single-phase 1~ 50/60Hz Full load current: 38 amps / 3.3kw	90-257v Single-phase 1~ 50/60Hz Full load current: 38 amps / 3.3kw
Noise level	< 70dBA (at typical operating speed)	< 70dBA (at typical operating speed)
Weight	156kgs	343lbs
Approvals	UKCA and CE	UKCA and CE

## HEPA filter specifications

Surface media area	7.5m <sup>2</sup> approx (80.7 ft <sup>2</sup> )
HEPA filter media	Hydrophobic borosilicate
HEPA media construction	Maxi pleat construction with glue bead spacers
Filter housing	Zintec mild steel
Filter efficiency	99.997% @ 0.3 microns

## Sponge coalescent filter (x2) specifications

Foam media	58 grade open cell foam
Dimensions	600 x 500 x 150 (x2)

## Gas filter specifications

Filter housing	Zintec mild steel
Treated activated carbon	30kgs (66 lbs)

## Unit part numbers

Model	Voltage	Part no.
PrintPRO 1200 DS stainless steel	115V - 230V	I4042A

## Options

24V start / stop	Filter change / system failure signal	VOC monitoring
A2001	A2002	A2003

## Replacement filter part numbers

Model	Part no.	Gas filter	HEPA filter
PrintPRO 1200 DS	A1030245	A1030246	A1030243

*Datasheet correct at time of publishing.*

*Where applicable, the carbon used in BOFA units is capable of removing a wide range of VOC's, however it is the responsibility of the user*

*to ensure the carbon is suitable for their application. For specific applications, please contact us for details.*

*Think before you print! Please consider the environment before printing this document.*

