



A Donaldson Company

A WORLD LEADER IN FUME
EXTRACTION TECHNOLOGY

PrintPRO 400 DS

PRINTING

Last Updated on 12.04.2021



Mid to high end fume extraction system for dye sublimation printers.

The PrintPRO 400 DS is BOFA's mid range of fume extraction and filtration system. The PrintPRO 400 DS has been purposely designed to filter the fumes generated from dye sublimation printers. This extraction system combines extremely large filter capacity with high airflows and pressure. This combination makes it ideal for heavy duty applications that generate large amounts of gaseous organic compounds. This system benefits from automatic flow control, which enables the end user to set the required airflow for the application. The unit will then maintain this airflow throughout the life cycle of the filters.

The additional feature of BOFA's 'easi-glide' filter location mechanism makes filter change easy, quick and safe. A truly state of the art fume purification solution.

Technology



HEPA filter



Automatic flow control (AFC) technology



Reverse flow air (RFA) technology



Advanced carbon filter (ACF) technology



ProTECT service plan



SureCHECK quality standard

Key features of the PrintPRO 400 DS

Hydrophobic HEPA filters
Standard

Filters with long life and low replacement cost
Standard

Automatic fluid drain
Standard

VOC gas sensor (Volatile Organic Compound)
Optional

Filter change / system fail signal
Optional

Turbines with high airflow and pressure
Standard

Automatic flow control system
Standard

Fluid collection tray
Standard

Remote stop / start interface
Optional

Contact BOFA at <https://bofainternational.com/en/contact/>

<https://bofainternational.com/en/portal/datasheets/printpro-400-ds/>







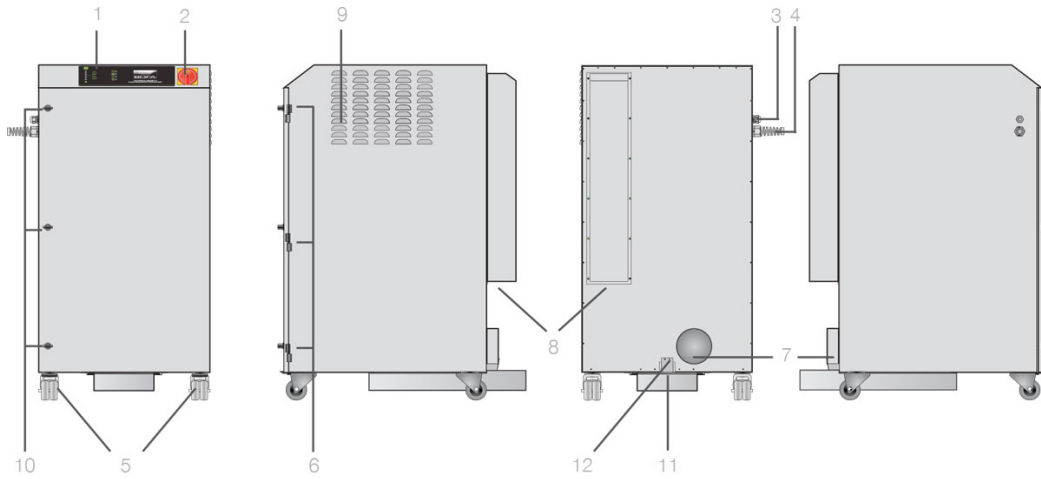

Technical specification

- | | | | |
|---|-----------------------------|-------------------------------------|--------------------------|
| 1. Unit / filter condition display - automatic flow control | 2. On / off isolator switch | 3. Signal / interface cable | 4. Power cable |
| 5. Castors | 6. Door hinge | 7. Hose inlet connections - 125mm | 8. Exhaust outlet |
| 9. Motor cooling inlet | 10. Door latch | 11. Removable fluid collection tray | 12. Automatic drain tray |



Airflow through filters

-  Chemical filter
-  HEPA filter
-  Sponge filter
-  Clean air
-  Contaminated air
-  Particulate

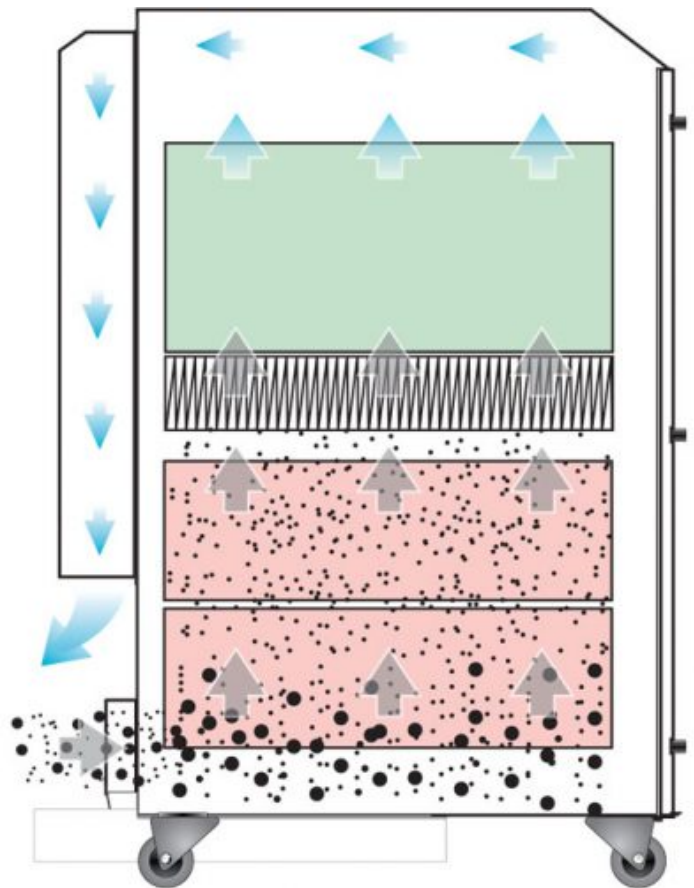

Technical data

	230V	115V
Dimensions (HxWxD)	1170 x 600 x 713mm	46.07 x 23.63 x 28.07"

Technical data

Cabinet construction	Stainless steel	Stainless steel
Airflow / pressure	380m ³ /hr / 96mbar	224cfm / 96mbar
Electrical data	90 - 257v Single-phase 1~ 50/60Hz Full load current: 12.5 amps / 1.1kw	90 - 257v Single-phase 1~ 50/60Hz Full load current: 12.5 amps / 1.1kw
Noise level	< 65dBA (at typical operating speed)	< 65dBA (at typical operating speed)
Weight	155kg	341lbs
Approvals	UKCA and CE	UKCA and CE

HEPA filter specifications

Surface media area	7.5m ² approx (80.7 ft ²)
HEPA filter media	Hydrophobic borosilicate
HEPA media construction	Maxi pleat construction with glue bead spacers
Filter housing	Zintec mild steel
Filter efficiency	99.997% @ 0.3 microns

Sponge coalescent filter (x2) specifications

Foam media	58 grade open cell foam
Dimensions	600 x 500 x 150 (x2)

Gas filter specifications

Filter housing	Zintec mild steel
Treated activated carbon	30kgs (66 lbs)

Unit part numbers

Model	Voltage	Part no.
PrintPRO 400 DS Stainless steel	115V - 230V	L3642A

Options

24V stop / start	Filter change / system failure signal	VOC monitoring
A2001	A2002	A2003

Replacement filter part numbers

Model	Sponge filter (x2)	Gas filter	HEPA filter
PrintPRO 400 DS	A1030245	A1030246	A1030243

Datasheet correct at time of publishing.

Where applicable, the carbon used in BOFA units is capable of removing a wide range of VOC's, however it is the responsibility of the user

to ensure the carbon is suitable for their application. For specific applications, please contact us for details.

Think before you print! Please consider the environment before printing this document.

